

**ORIGINAL VIDEO GAME**

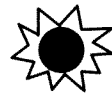

# **ZERO POINT™**

**GUN SHOOTING GAME**

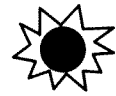

## **OPERATOR'S**

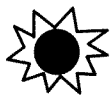

## **MANUAL**

©1998 UNICO ELECTRONICS CO., LTD.

# **SPECIAL NOTICE**

## **Sound wiring change**

Please follow the speaker wiring instructions to avoid a distorted sound for the stereo.

The cabinet with one speaker:

Pin 10 goes to speaker and run ground to the negative side of speaker.

The cabinet with two speakers:

Pin 10 goes to the right speaker

Pin J goes to the left speaker and run a ground wire to the negative side of speakers.

If you have any problems or questions regarding this matter, please feel free to call for technical support at GameVision.

# INTRODUCTION

1-1. EXPLANATION OF GAME SCREEN	2
1-2. EXPLANATION OF THE SHOOTING GUN	2
2-1. GAME SETTING SCREEN (BASIC ITEMS)	3
2-2. GUN TEST SCREEN	3
2-3. INPUT SCREEN	4
2-4. SOUND & VOICE TEST SCREEN	4
2-5. COLOR SCREEN	5
2-6. DIP CONFIGURATION SCREEN	5
3-1. DIP SWITCH TABLE	6
3-2. DIP SWITCH A	6
3-3. DIP SWITCH B	7
3-4. GUN CONNECTOR	7
4-1. CONNECTOR SPEC	8

## 1-1. EXPLANATION OF GAME SCREEN

“ Move over video games, here’s the real thing!”

Basic explanation of displays on the screen during the game.

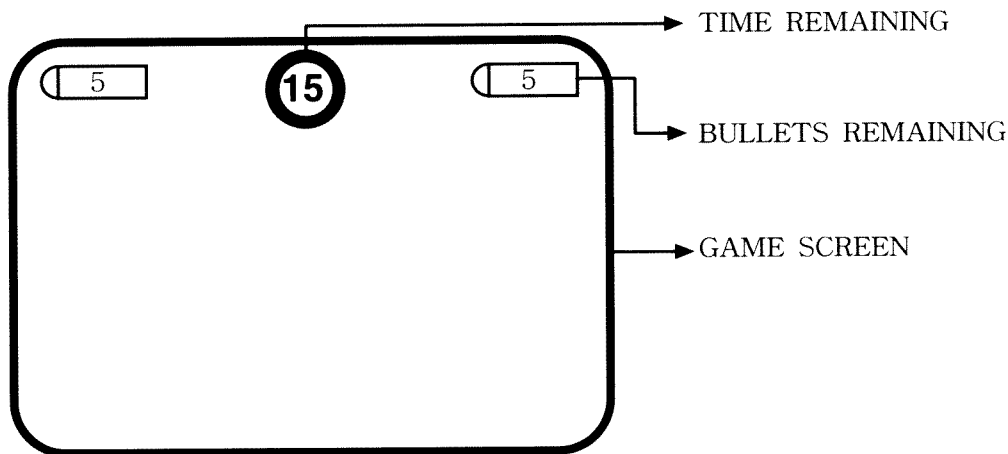

## 1-2. EXPLANATION OF THE SHOOTING GUN

\* Everytime you shoot, the hammer of the gun will trigger like a real gun.

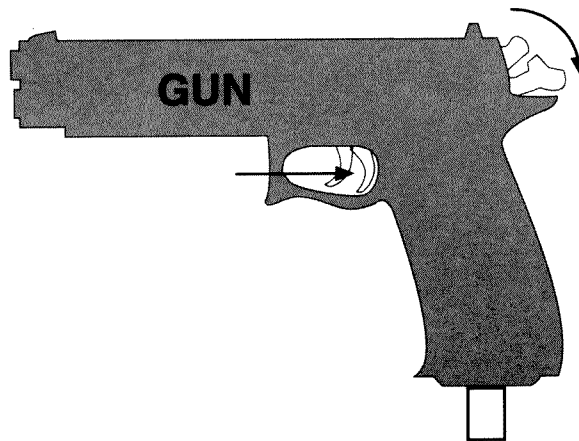

### \* WARNING \*

Do not try to hold the hammer of the gun or move the hammer of the gun with your hand.

Do not hit, throw or any other way vandalize the gun.

Do not abuse or use excessive force against gun.

## 2-1. GAME SETTING SCREEN (BASIC ITEMS)

Manually check and change the settings for the screen displays and game controls.

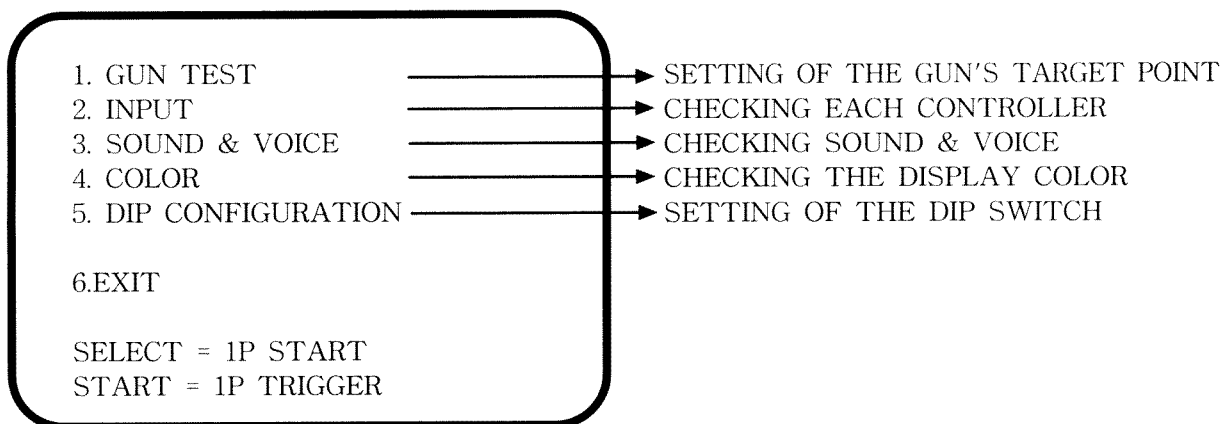

## 2-2. GUN TEST SCREEN

Mode for checking the shooting target positions.

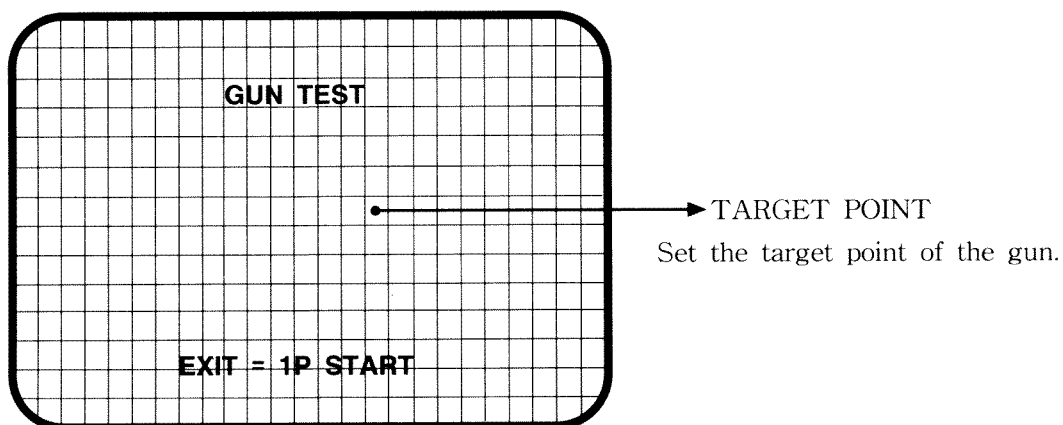

## 2-3. INPUT SCREEN

Mode for checking the performance of each control  
( Coin, Service coin, Start button, Trigger )

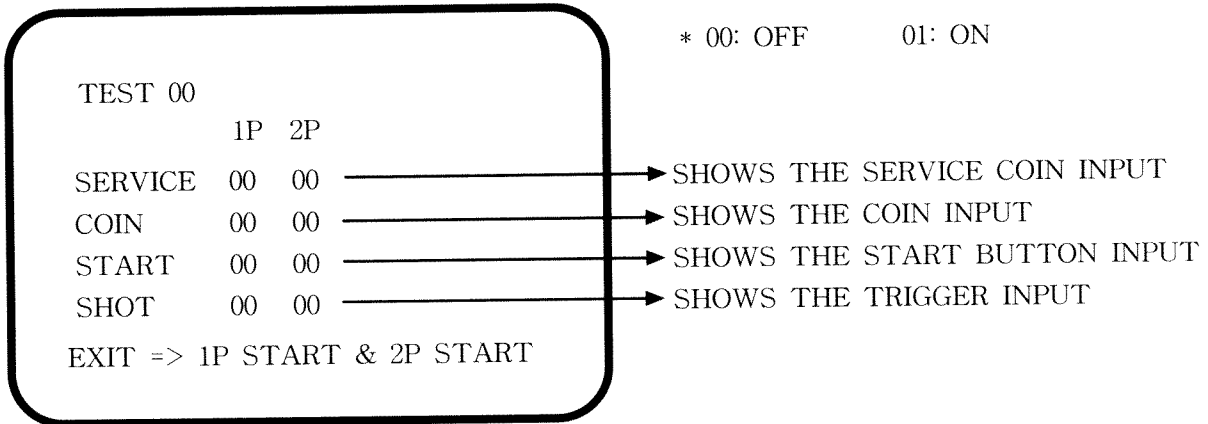

## 2-4. SOUND & VOICE TEST SCREEN

Mode for checking the sound & voice.

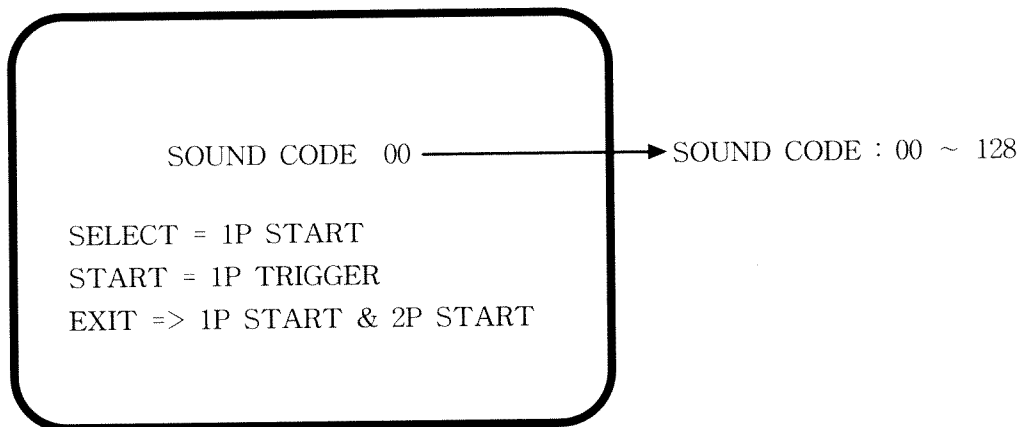

## 2-5. COLOR SCREEN

Mode for checking the display color.

The colors of the color bars should appear properly graduated.

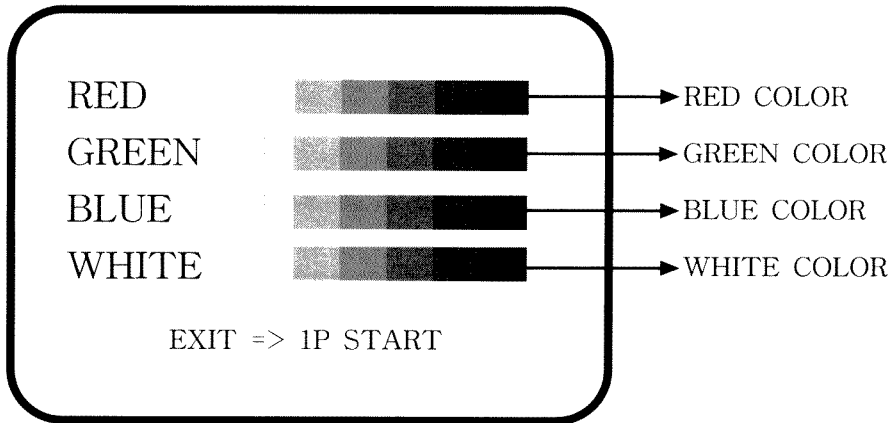

## 2-6. DIP CONFIGURATION SCREEN

Dip switch setting mode.

When changing the dip switch settings, set the dip switch by referring to the dip switch table.

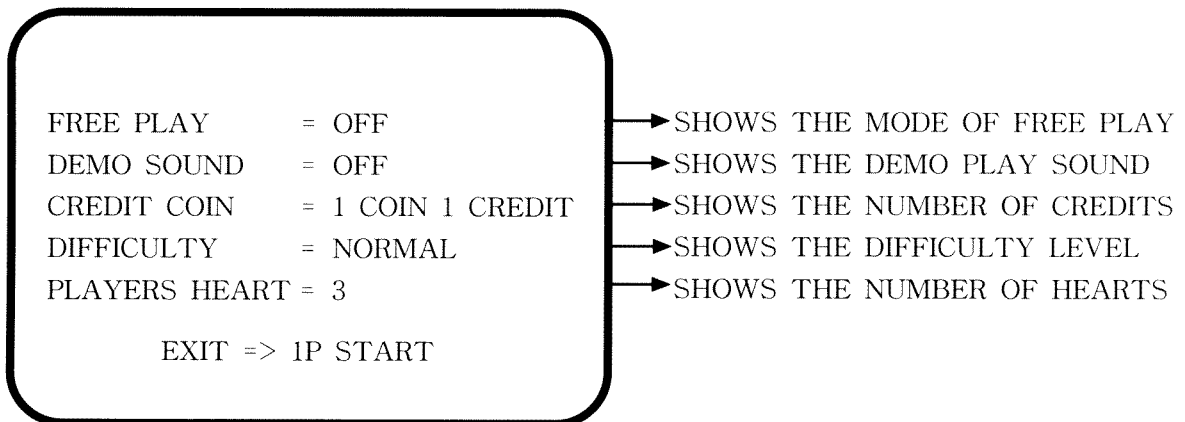

\* CREDIT COIN SETTING : 8 kinds of settings.

\* DIFFICULTY SETTING : 3 kinds of settings. ( EASY, NORMAL, HARD )

\* PLAYERS HEART SETTING : 4 kinds of settings.

( 2 HEART, 3 HEART, 4 HEART, 5 HEART )

\* The coin setting options are not displayed with free play is set to "ON"

# 3-1. DIP SWITCH TABLE

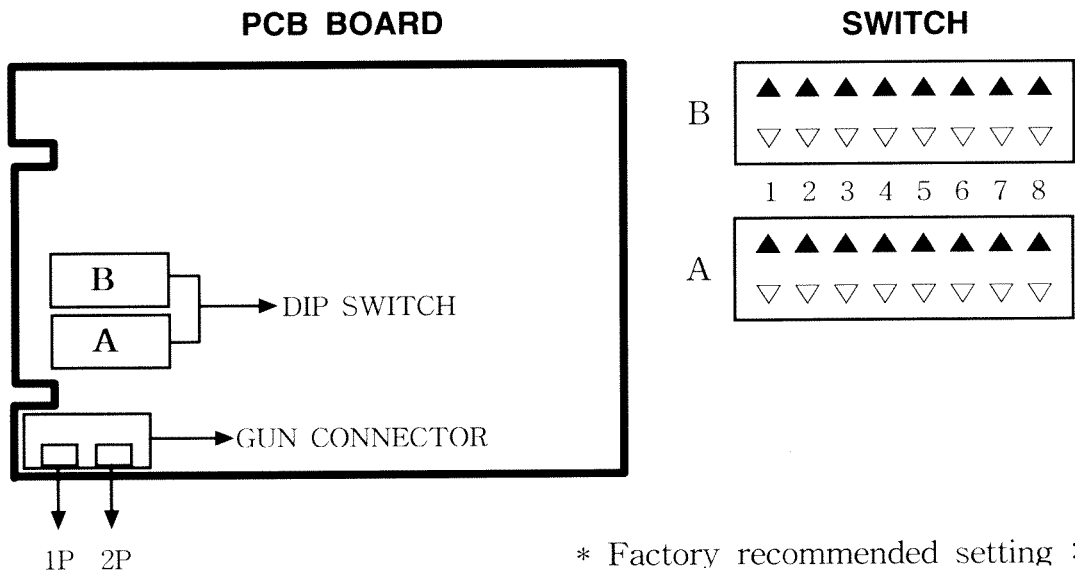

\* Factory recommended setting : All off

# 3-2. DIP SWITCH A

ITEM	DESCRIPTION	1	2	3	4	5	6	7	8
Free Play	On		ON						
Demo Sound	On				ON				
Coin - Credit	1 Coin 1 Credit						OFF	OFF	OFF
	1 Coin 2 Credit						ON	OFF	OFF
	1 Coin 3 Credit						OFF	ON	OFF
	1 Coin 4 Credit						ON	ON	OFF
	2 Coin 1 Credit						OFF	OFF	ON
	3 Coin 1 Credit						ON	OFF	ON
	4 Coin 1 Credit						OFF	ON	ON
	5 Coin 1 Credit						ON	ON	ON



## 3-3. DIP SWITCH B

ITEM	DESCRIPTION	1	2	3	4	5	6	7	8
Difficulty	Easy					ON	OFF		
	Normal					OFF	OFF		
	Hard					OFF	ON		
Player's Heart	2							ON	OFF
	3							OFF	OFF
	4							OFF	ON
	5							ON	ON

## 3-4. GUN CONNECTOR

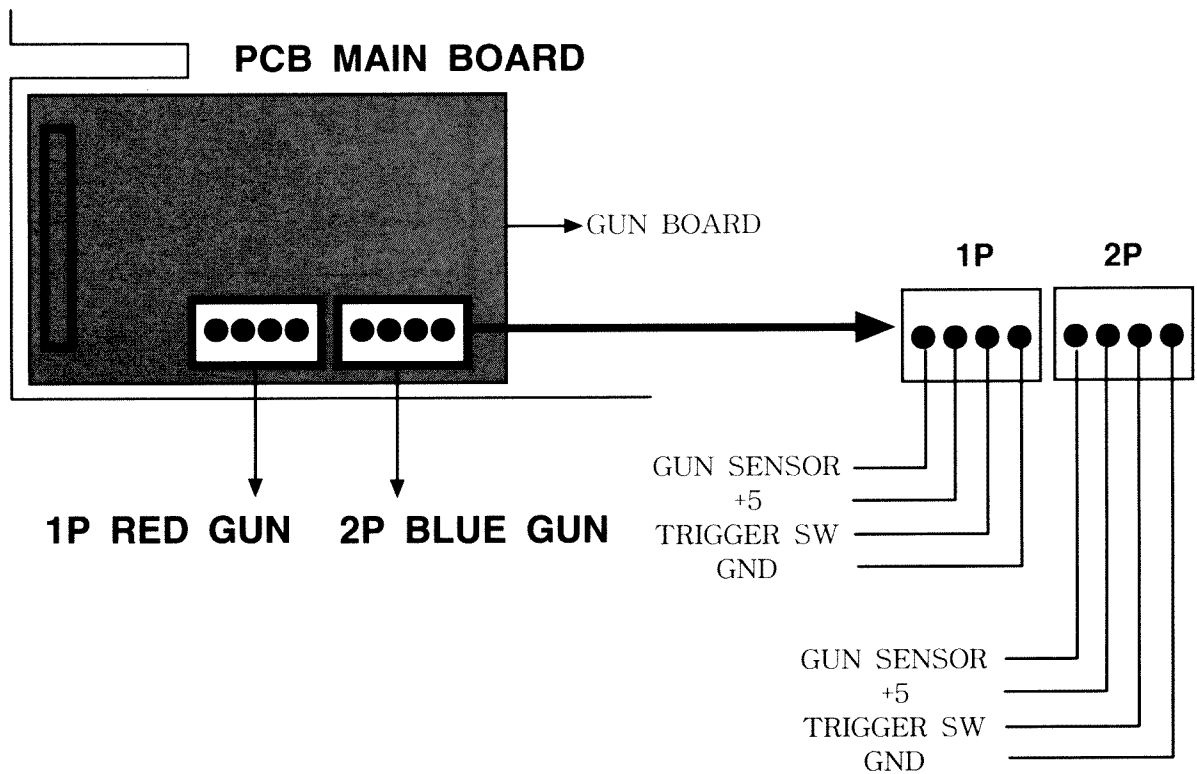

## 4-1. CONNECTOR SPEC

Solder Side	Terminal		Parts Side
GND	A	1	GND
GND	B	2	GND
+5	C	3	+5
+5	D	4	+5
NC	E	5	NC
+12	F	6	+12
NC	G	7	NC
NC	H	8	Coin Counter
2P LAMP	I	9	1P LAMP
Speake+ (L)	J	10	Speake+ (R)
NC	K	11	NC
Video GREEN	L	12	Video RED
Video SYNC	M	13	Video BLUE
Service SW	N	14	GND
NC	O	15	Test SW
2P Coin Switch	P	16	1P Coin Switch
2P Start	Q	17	1P Start
NC	R	18	NC
NC	S	19	NC
NC	T	20	NC
NC	U	21	NC
NC	V	22	NC
NC	W	23	NC
NC	X	24	NC
NC	Y	25	NC
NC	Z	26	NC
GND	a	27	GND
GND	b	28	GND