

**DATA
EAST**

wacky gator

Installation and Service Manual

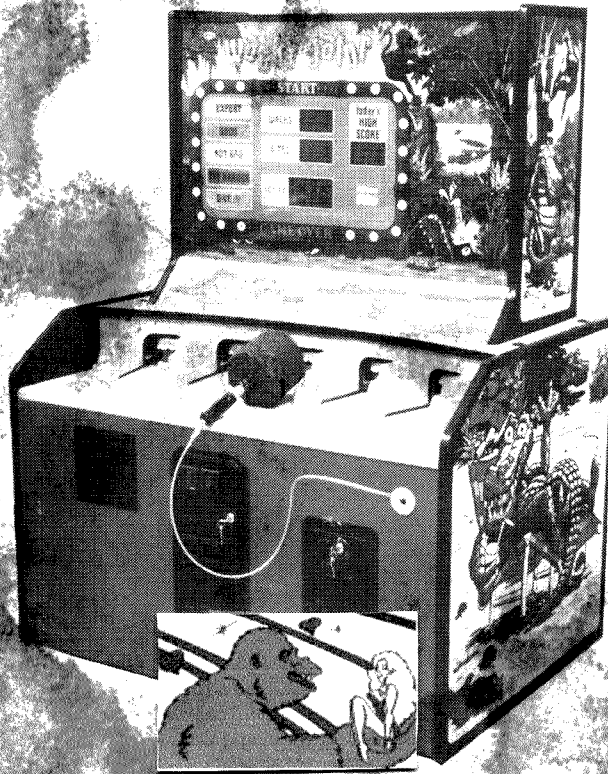

Manufactured by DATA EAST USA, INC
1850 Little Orchard St.
San Jose, CA 95125-1045
Designed by NAMCO

Underwriters Laboratories listed game

780-0159-00 Rev. D

No part of this publication may be reproduced by any mechanical, photographic or electronic process, or in the form of a phonographic recording, nor may it be stored in a retrieval system, transmitted or copied for public or private use, without permission of the publisher.

The game play, all graphic designs, this technical manual and its accompanying schematic diagrams are protected by the U.S. Copyright Act of 1976.

This act provides substantial penalties for violating federal copyright laws. Courts can impound infringing articles while legal action is pending. If infringers are convicted, courts can order destruction of the infringing articles.

In addition, the Act provides for payment of statutory damages of up to \$50,000 per infringing transaction, in certain cases. Infringers may also have to pay cost and attorney's fees and face an imprisonment of up to five years as well as fines of up to \$250,000 in the case of individuals, and up to \$500,000 in the case of corporations.

DATA EAST will aggressively enforce its copyrights against infringers. We will use all legal means to immediately halt any manufacture, distribution or operation of a copy of any games made by us. Anyone who purchases such copies risks forfeiting such a game.

Published by:
DATA EAST CORPORATION
1850 Little Orchard Street
San Jose, CA 95125-1045
(408) 286-7080 Phone
(408) 291-0722 Fax

Printed in the U.S.A. Produced by Data East Technical Publications
Department.

TABLE OF CONTENTS

Installation & Operation

Disclaimers and Safety Guide	1
Notice Regarding Non-Data East Parts	2
Game Specifications	3
Game Description	3
Automatic Difficulty Adjustment	4
Ticket Dispenser	4
Back Glass Display	4
Timing Lights	5
Service Panel	5
Error Codes	5
Maintenance Connector	7
Option Switch Settings	7
Test Mode	9
Disassembly and Reassembly	11

Appendix A — Replacement Parts

Drive Assembly	14
Character Assembly	16
Front View	18
Shadow Box Assembly	19
Playfield Assembly	20
Service Panel	21
Display PCB	22
Game PCB	23
Character/Mounting Assemblies	24
Ticket Holder	25

Appendix B — Wiring Diagrams

Power Supply Wiring Diagram	28
Timing Lights Wiring Diagram	29
Service/Ticket/Prize Wiring Diagram	30
Character/Drive Assembly Wiring Diagram	31

Installation & Operation

Appendix A
Replacement Parts

Appendix B
Wiring Diagrams

This Page Intentionally Left Blank

wacky gator

Installation & Operation

INSTALLATION & OPERATION

This Page Intentionally Left Blank

DISCLAIMERS & SAFETY GUIDE

The following safety precautions apply to all game operators and service personnel. Specific warnings and cautions will be found in this manual whenever they apply.

WARNING

Properly Ground the Game

Players may receive an electrical shock if this game is not properly grounded! To avoid electrical shock, do not plug in the game until it has been inspected and properly grounded. This game should only be plugged into a grounded three-wire outlet. If you have only a two-wire outlet, we recommend you hire a licensed electrician to install a three-wire grounded outlet. If the coin door is not properly grounded, players may receive an electrical shock! After servicing any part on the doors, check that the grounding wire is firmly secured to the inside of the control panel. After you have verified this, lock up the game.

AC Power Connection

Before you plug in the game, be sure that the game's power supply can accept the AC line voltage in your location. The line voltage requirements are contained within this manual.

Disconnect Power During Repairs

To avoid electrical shock, disconnect the game from the AC power before removing or repairing any part of the game. The power supply capacitors retain energy for a period of time even after AC power is removed. Use care when working near them or on any circuitry connected to them.

Use the Proper Fuses

To avoid electrical shock, use replacement fuses which are specified in the parts list for this game. Replacement fuses must match those replaced in fuse type, voltage rating, and current rating. In addition, the fuse cover must be in place during game operation. Refer to the Power Supply wiring diagram for more information.

CAUTION**Properly Attach All Connectors**

Make sure that the connectors on each printed circuit board (PCB) are properly plugged in. The connectors are keyed to fit only one way. If they do not slip into place easily, do not force them. If you reverse a connector, you may damage your game and void your warranty.

NOTICE REGARDING NON-DATA EAST PARTS**WARNING**

Use of non-DATA EAST parts or modifications of any DATA EAST game circuitry may adversely affect the safety of your game, and may cause injury to you and your players.

Note: This equipment generates, uses, and can radiate radio frequency energy, and if not installed and used in accordance with the instruction manual, may cause interference to radio communications. It has been tested and found to comply with the limits for a Class A computing device pursuant to Subpart J of Part 15 of Federal Communications Commission (FCC) Rules, which are designed to provide reasonable protection against such interference when operated in a commercial environment. Operation of this equipment in a residential area or modification to this equipment is likely to cause interference, in which case the user, at his own expense, will be required to take whatever measures may be required to correct the interference. If you suspect interference from a DATA EAST game at your location, check the following:

- All ground wires in the game are properly connected as shown in the game wiring diagram.
- The power cord is properly plugged into a grounded three wire outlet.

GAME SPECIFICATIONS

Characteristic	Specifications
Power Consumption	350 VA 110 V RMS
Temperature	+5 to +50° C (+37° to +122° F)
Humidity	Not to exceed 95% relative
Line Voltage	102 – 137 VAC 60 Hz (U.S. Games)
Width	47"
Depth	34"
Height	66"
Weight	400 lbs.

Table 1 Game Specifications

GAME DESCRIPTION

WACKY GATOR™ is a simple and easy-to-play game which entertains players of all ages. An automatic difficulty adjustment makes the game more difficult for skillful players, and yet easy for younger players.

The game starts automatically when a coin is dropped into either coin slot. The 'gators will randomly come out of their caves and move toward the front of the play field. The object of the game is to whack the 'gator with the "whacker" before it reaches the "bite zone" or can retreat to its cave. The player cannot score extra points by whacking a 'gator more than once on each of its excursions. Only the first whack counts. The player does not score extra points by hitting harder; a light touch will activate the circuits and will lead to higher scores. At the beginning of play, all the lights will be illuminated. As play continues, timing lights are extinguished until, at the end of the game, all the lights are extinguished.

Each time a 'gator is successfully whacked, one wack is registered in the WACKS display window.

If a 'gator reaches the "bite zone" before it is whacked, a gruff voice says "MUNCH", and one bite is registered in the BITES display window.

If the player scores 40 points or more, they are awarded a 10-second bonus play period, and any additional wacks or bites are added to the appropriate display window.

At the end of the game, BITES are subtracted from WACKS to determine the SCORE that is displayed in the corresponding window.

AUTOMATIC DIFFICULTY ADJUSTMENT

The Wacky Gator game senses the rate at which 'gators are whacked and automatically adjusts the difficulty of the game so that it is more difficult for experienced players, and remains easy for small children to play. The game difficulty cannot be changed with DIP switch settings.

TICKET DISPENSER

Each Wacky Gator game is shipped from the factory with a Deltronics Labs Inc. model DL-1275 Ticket Dispenser installed. Tickets are dispensed as the game is played. The number of points per ticket dispensed is selectable with the DIP switch on the Game PCB.

The Ticket Dispenser Door includes:

- Ticket counter
- Low Ticket Switch
- Low-ticket Indicator - this indicator illuminates whenever the stack of tickets falls below approximately 200.

For maintenance and troubleshooting instructions concerning the Ticket Dispenser, refer to the Deltronics manual included with the game.

The manufacturer reserves the right to change equipment and features at any time in its efforts to produce the best product possible.

BACK GLASS DISPLAY

The Back Glass display contains four windows and five annunciators. The window labelled WACKS shows the total number of 'gators that the player strikes.

The window labelled BITES shows the total numbers of times the 'gators have "munched" the player. The player is "munched" if the 'gator reaches the "Bite Zone" without being "whacked".

The window labelled SCORE displays the player's score. Wacks minus Bites equals Score.

The window labelled TODAY'S HIGH SCORE shows the highest score achieved since the game was last turned on.

One of the five annunciators will be illuminated at the end of the game, depending on the score achieved. The annunciator legend and the corresponding scores are:

Annunciator	Required Points
YOU WIN	80 or greater
GOOD	70 — 79
NOT BAD	50 — 69
TRY HARDER	30 — 49
GIVE UP	Less than 29

Table 2 Game Scoring

Annunciator (sometimes called "shadow box") lamps should be a high-brightness, 24 or 28 volt type. For uniform brightness, all lamps should be the same type. Sylvania type 24MB lamps are recommended as a good, long-life (average 10,000 hr.) lamp. These lamps are available from many local electronics distributors, or from the DATA EAST parts department. Refer to the Replacement Parts section of this manual for part numbers.

TIMING LIGHTS

A series of lighted dots surround the score display area. At the beginning of play, they are all lit. As the game progresses, lights are extinguished as the timer counts down.

During Attract mode, the lights flash alternately.

The timing lights use 28 volt lamps. For uniform brightness, all lamps should be the same type. Lamp type #1819 is a good 28 volt, long-life (avg. life 2500 hr.) lamp. For higher brightness, Sylvania type 24MB lamps (avg. life 10,000 hr.) are recommended. These lamps are available from many local electronics distributors, or from the DATA EAST parts department. Refer to the Replacement Parts section of this manual for part numbers.

SERVICE PANEL

The Service Panel is located behind the coin door assembly, and includes:

- Coin Counter — increments once each time a coin is dropped through either coin slot.
- Volume Control — adjusts the volume of the game sounds. It is set to the middle of its range at the factory.
- Service switch — the upper button on the Service Panel, it is used to start the game without incrementing the coin counter.
- Test switch — the lower button on the Service Panel, it is used to enter Test mode, and to step through the sequence of game tests.

ERROR CODES

If a problem occurs during play, the an alarm will sound, and an error code will be displayed in all the display windows. The error codes and some possible causes are listed in the table below.

Error Code	Possible Cause
11	All 'gators have not returned to the cave properly, or the system does not recognize that they have returned to their "stowed" position. A) Check for mechanical obstacles. B) Reset the game by turning the power off then back on. C) If all 'gators appear mechanically correct, use the Maintenance Connector to isolate the faulty 'gator. D) Check the operation of the Rear Sensor PCB. E) Check for a faulty motor.
22	'gators do not move, or do not reach the "bite zone". A) Check for mechanical obstacles. B) Reset the game by turning the power off then back on. C) If all 'gators appear mechanically correct, use the Maintenance Connector to isolate the faulty 'gator. D) Repair or replace defective sensor or motor. E) Repair or replace defective 'gator. Note that during normal play, the 'gators might not reach the "bite zone" each time they leave the cave. This is controlled by the automatic difficulty adjustment program.
10	Defective Test switch. Repair or replace.
20	Defective Service switch. Repair or replace.
30	Test and Service switches are both on.
40	Coin switch is on.
50	Test and coin switches are both on.
60	Service and Coin switches are both on.
70	Test, Service, and Coin switches are all on.

MAINTENANCE CONNECTOR

The Maintenance Connector is a 15-pin Molex plug (0.062" male pins) with jumpers installed as shown in the figure below. A Maintenance Connector is included with each game. When the game is shipped, it is hanging from a plastic hook on the side of the shadow box (annunciator panel) inside the top box.

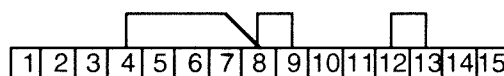

There are five 'gators in the game, and failure of any one of them will cause the alarm to sound. The Maintenance Connector can be used to isolate the defective character set ('gator and drive unit).

TURN OFF THE POWER! Open the rear door of the top box, and locate the 15-pin connector for each of the character units. As viewed from the rear, the plugs correspond to the character units as follows:

'gator	Connector
Far left 'gator	J20 (red dot)
2nd from left	J21 (blue dot)
Center 'gator	J22 (no dot)
2nd from right	J23 (blue dot)
Far right 'gator	J24 (red dot)

Table 3 Character Unit Connectors

Unplug the connector for the suspected defective 'gator, and plug the Maintenance Connector in its place. Turn on the Power. If the alarm still sounds, the chosen 'gator is not the defective one. If this is the case, turn off the Power, select another 'gator, and repeat the procedure.

When the defective 'gator has been isolated, check the unit for loose wires, etc. Although it is not recommended, the game can be operated with the Maintenance Connector replacing a defective 'gator. Scores will be reduced and extra Bites may appear.

OPTION SWITCH SETTINGS

Be sure to **TURN POWER OFF** before changing the Option Switch settings.

The Option Switch is located on the Game PCB, which is located on the Top Box door. The Option Switches control the number of coins per game, number of tickets or prizes dispensed, and Attraction mode sound on/off.

Option	Sw 1	Sw 2	Sw 3	Sw 4	Sw 5	Sw 6
1 coin – 1 game 1 ticket/5 points	ON	ON	ON			
1 coin – 1 game 1 ticket/10 points	ON	ON	OFF			
1 coin – 1 game 1 ticket/15 points	ON	OFF	ON			
2 coin – 1 game 1 ticket/5 points	OFF	ON	OFF			
2 coin – 1 game 1 ticket/10 points	OFF	OFF	ON			
For factory Test use ONLY! Do not change				OFF		
Attract Mode Sound ON					ON	
Attract Mode Sound OFF					OFF	
For factory Test use ONLY! Do not change						OFF

Table 4 Option Switch Settings – Standard EPROM

There are two optional EPROMs available at extra cost which change the range of the points/ticket settings on the Option Switches.

Option	Sw 1	Sw 2	Sw 3	Sw 4	Sw 5	Sw 6
1 coin – 1 game 1 ticket/10 points	ON	ON	ON			
1 coin – 1 game 1 ticket/20 points	ON	ON	OFF			
1 coin – 1 game 1 ticket/30 points	ON	OFF	ON			
2 coin – 1 game 1 ticket/10 points	OFF	ON	OFF			
2 coin – 1 game 1 ticket/20 points	OFF	OFF	ON			
For factory Test use ONLY! Do not change				OFF		
Attract Mode Sound ON					ON	
Attract Mode Sound OFF					OFF	
For factory Test use ONLY! Do not change						OFF

Table 5 Option Switch Settings – First Alternate EPROM SET – P/N 965-0003-01

Option	Sw 1	Sw 2	Sw 3	Sw 4	Sw 5	Sw 6
1 coin – 1 game 1 ticket/15 points	ON	ON	ON			
1 coin – 1 game 1 ticket/25 points	ON	ON	OFF			
1 coin – 1 game 1 ticket/35 points	ON	OFF	ON			
2 coin – 1 game 1 ticket/15 points	OFF	ON	OFF			
2 coin – 1 game 1 ticket/25 points	OFF	OFF	ON			
For factory Test use ONLY! Do not change				OFF		
Attract Mode Sound ON					ON	
Attract Mode Sound OFF					OFF	
For factory Test use ONLY! Do not change						OFF

Table 6 Option Switch Settings – Second Alternate EPROM Set – P/N 965-0003-02

TEST MODE

There are two buttons on the Service Panel. The upper button is the Service switch, which allows credits to be installed in the game without incrementing the coin counter. The lower button is the Test switch. Pressing the Test button repeatedly causes the game to enter each Test mode in sequence.

1. Press the lower button once to enter Display Test mode. Each segment of the seven-segment LED display indicators will become illuminated in sequence, to check for faulty segments. Then each of the timing lights and each of the annunciator lights will become illuminated in sequence.
2. Press the Test button a second time to enter Gator Test mode. Each 'gator will come out of its cave in sequence. Use this mode to insure that each 'gator says "ouch" when you hit it on the head, and says "munch" when it reaches the "bite zone" at the end of its travel. Note that, during normal play, each 'gator might not travel all the way to the "bite zone" each time it leaves its cave. This is a function of the automatic difficulty control program.
3. Press the Test switch a third time to end the Gator Test mode and enter Switch Test mode. There are 5 individual tests in Switch Test mode.
 - Dropping a coin through either coin slot, or activating the coin switch, causes the TODAY'S HIGH SCORE window to display the numeral 2.
 - Pressing the SERVICE switch causes the TODAY'S HIGH SCORE window to display the numeral 1.

- Activating the coin switch and pressing the SERVICE switch simultaneously causes the TODAY'S HIGH SCORE window to display the numeral 3.
 - During Switch Test mode, the SCORE window shows the coins/play setting of the Options Switches. For example, 21 displayed indicates 2 coins per 1 play; 11 displayed indicates 1 coin per 1 play. Refer to the Option Switch Settings tables for further information.
 - The WACKS window shows the setting of the Attract Mode Sound switch (Sw 6), with 1 indicating that the switch is on, and 0 indicating that the switch is off.
4. Press the Test button a fourth time to enter Sound Test mode. Each of the game sounds will be emitted in the following sequence:
 1. Descending scale.
 2. "Game Play" music.
 3. Ascending scale.
 4. "Game Play" music, but faster than item 2 above.
 5. Two, quick ascending scales.
 6. A gruff voice saying "I'm gonna get you!"
 7. The word "Ouch".
 8. The word "Munch".
 9. The words "You missed me".
 10. The words "You can do better".
 11. The words "Try harder!".
 12. The words "Pretty good!".
 13. The words "You win!".
 14. The alarm sounds once.
 5. Press the Test switch a fifth time to enter idle mode. After five minutes, the game will automatically reset to Game mode. Or, press the Test switch a sixth time to return to Game mode immediately.

DISASSEMBLY AND REASSEMBLY

Make sure the power supply is turned OFF and the power cord is unplugged before beginning any disassembly.

Removing the Character Assembly

1. Remove the four button head screws that hold the Top Box.
2. Tilt the Top Box back on its hinges to expose the Character/ Drive assemblies.
3. Loosen the Nylock nuts that hold the Slopes to the upper side of the 'gators.
4. Disconnect the 3-pin connector from each Character Assy.
5. Push the Character Assy backward while lifting it off the driving unit.

Removing the Drive Assembly

1. Remove the Character Assy from the Drive Assy.
2. Open the Coin Door and unlock the two latches that secure the Playfield. Lift the Playfield about 2 - 3" and pull it toward you to remove it.
3. Disconnect the 12-pin connector from each Drive Assy.
4. Remove the 1/4 - 20 bolt at each end of the Drive Assy. **Do not** misplace the 1/8" plastic shim, cone washer, fender washer, or split lock washer when removing the bolt.

Replacing the Drive Assembly

1. Place the 1/8" plastic shim so that its hole lines up with the Drive Assy mounting hole. Put the Drive Assy on the plastic shims.
2. Put the cone washer in the hole in the Drive Assy. **Make sure it is not trapped under the Drive Assy.**
3. Put the fender washer, split lock washer, and bolt in place and tighten.
4. Reconnect the 12-pin connectors to the Drive Assemblies.
5. Replace the Playfield, and lock its latches.

Replacing the Character Assembly

1. Replace the 'gators on the Playfield, making sure the shafts are inside the collar joints before replacing the slopes on top of the 'gators.
2. Replace the Nylock nuts that attach the slopes.
3. Reconnect the 3-pin connectors to the 'gators.
4. Return the Top Box to its normal, upright position, and secure it with the button head bolts.

Removing and replacing Side Guards (dividers)

1. Remove the four button head screws that hold the Top Box.
2. Tilt the Top Box back on its hinges to expose the Character/ Drive assemblies.
3. Loosen the Nylock nuts that hold the Slopes to the front slope bracket.
4. Disconnect the 3-pin connector from each Character Assy.
5. Push the Character Assy backward while lifting it off the driving unit.
6. Open the Coin Door and unlock the two latches that secure the Playfield. Lift the Playfield about 2 – 3" and pull it toward you.
7. Remove the Side Guard by removing the two recessed 3/8" X 2-1/4" bolts that attach it to the Playfield.
8. When replacing the Side Guard, make sure to replace the fender washer and split lock washer on each bolt.
9. Replace the Playfield and lock its latches.
10. Replace the 'gators on the Playfield, making sure the shafts are inside the collar joints before replacing the slopes on top of the 'gators.
11. Replace the Nylock nuts that attach the slopes.
12. Reconnect the 3-pin connectors to the 'gators.
13. Return the Top Box to its normal, upright position, and secure it with the button head bolts.

wacky gator

REPLACEMENT PARTS

NOTE: *The following parts lists contain DATA EAST Part Numbers for only the major replaceable parts for each assembly. If a required part is not listed, contact the DATA EAST Customer Service Department.*

Wacky Gator™ games having serial numbers after 315000 are UL Recognized in accordance with UL 22. To insure continued compliance, parts marked with an * must be replaced with genuine Data East parts.

DRIVE ASSEMBLY – 510-0177-00

Item	DE Part No.	Description	
01	535-0255-00	Rail	
02	535-0256-00	End Bracket (A)	
03	535-0257-00	End Bracket (B)	
04	535-0258-00	Shaft Bracket, Gear	
05	535-0259-00	Front Stopper	
06	535-0260-00	Motor Bracket	
07	535-0261-00	Sensor Wing (A)	
08	535-0123-00	Sensor Wing (B)	
09	535-0262-00	Sensor Bracket	
10	535-0263-00	Shaft	
11	235-0123-00	Collar Joint	
12	535-0264-00	Rack	
13	325-0002-00	Coupling	
13a	325-0003-00	Coupling Spider	
13b	325-0004-01	Hub for 1/4" shaft (at one end)	
13c	325-0004-02	Hub for 5/15" shaft (at other end)	
14	535-0265-00	Lock Bracket	
15	535-0124-00	Lock Finger	
16	285-0001-00	Cushion (D)	
17	260-0007-00	Bearing	
18	260-0010-00	Bearing	
19	300-0007-00	Spur Gear	SIS40B+0608 KG
20	280-0009-00	Collar	
21	080-0003-00	Stepper Motor	Ph266-01-A67 Oriental
22	520-0097-00	Sensor PCB	
23	090-0003-00	Solenoid	
24	121-0007-00	Ceramic Resistor	
27	242-0015-00	Washer, Conical Spring (used as spacer)	
28	244-0002-00	Washer, Split Lock	
29	231-0001-06	Bolt, 1/4-20 X 1-1/4	
30	535-0142-00	Plastic Shim, 1/8"	

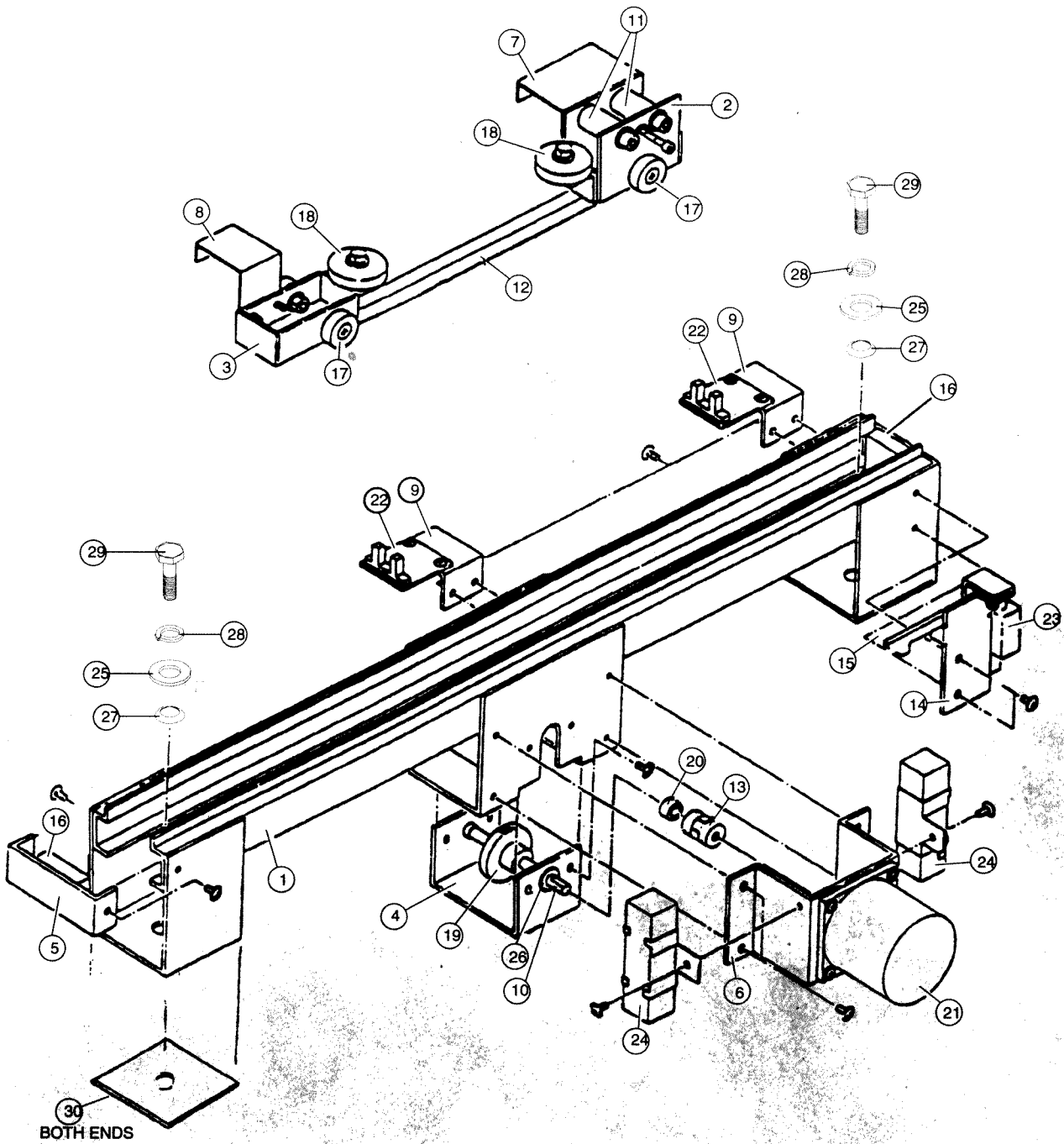

CHARACTER ASSEMBLY – 510-0176-00

Item	DE Part No.	Description	
01	545-0013-00	Face (without eyeball decal)	
02	545-0014-00	Body	
03	545-0043-00	Chin	
04	535-0208-00	Chassis	
06	535-0237-00	Upper Stopper	
07	535-0125-00	Sensor Plate	
08	535-0238-00	Suspension Blade	
09	530-0043-00	Suspension Shaft	
10	530-0042-00	Roller Shaft	
11	530-0044-00	Neck Shaft	
12	530-0045-00	Opener Shaft	
13	535-0239-00	Suspension Leaf	
14	267-0003-00	Opener Spring	
15	267-0004-00	Absorber Spring	
16	285-0016-00	Cushion	
17	520-0097-00	Sensor PCB	
18	280-0008-00	Body Stopper (Bushing)	
19	285-0015-00	Neck Cushion	
20	285-0002-00	Side Cushion	
21	285-0017-00	Cushion, Suspension	
22	285-0003-00	Cushion (A), Shoulder	
23	285-0004-00	Cushion (B), Tongue	
24	285-0005-00	Cushion (C), Chassis	
25	545-0044-00	Tongue	
26	406-0289-00	Decal Set, Wacky Eyeballs (set of 5 different)	
27	260-0008-01	Roller Tire for Slope	
28	260-0009-00	Rollers for body (sold in pairs only)	
29	239-0007-00	Well Nut, KT-5	KURASHIKI
30	280-0020-00	Bushing for Opener Shaft	
31	251-0003-00	Snap Pin	8ZC
32	251-0004-00	Snap Pin	12ZC
33	280-0022-00	Bushing for Roller Shaft	
34	250-0012-00	Retainer Ring	
35	242-0008-00	Flat Washer	
36	535-0192-00	Frame, Lever (guide for Slope)	
37	160-0005-00	Optical Coupler only	
38	280-0017-00	Bushing for Opener Shaft	
39	237-0023-17	Screw, 10-32X3/4 Truss Hd Phil	
40	242-0008-00	Washer, 1/4" flat	
41	232-0009-07	Screw, 10-32X1-1/4"	
42	242-0022-00	Washer, 5/16" flat	
43	515-0144-00	Suspension leaf w/ wheels	

Complete Wacky Gator Character Assembly
510-0176-00
Metal Assembly only (without parts in dotted line)
515-0069-00

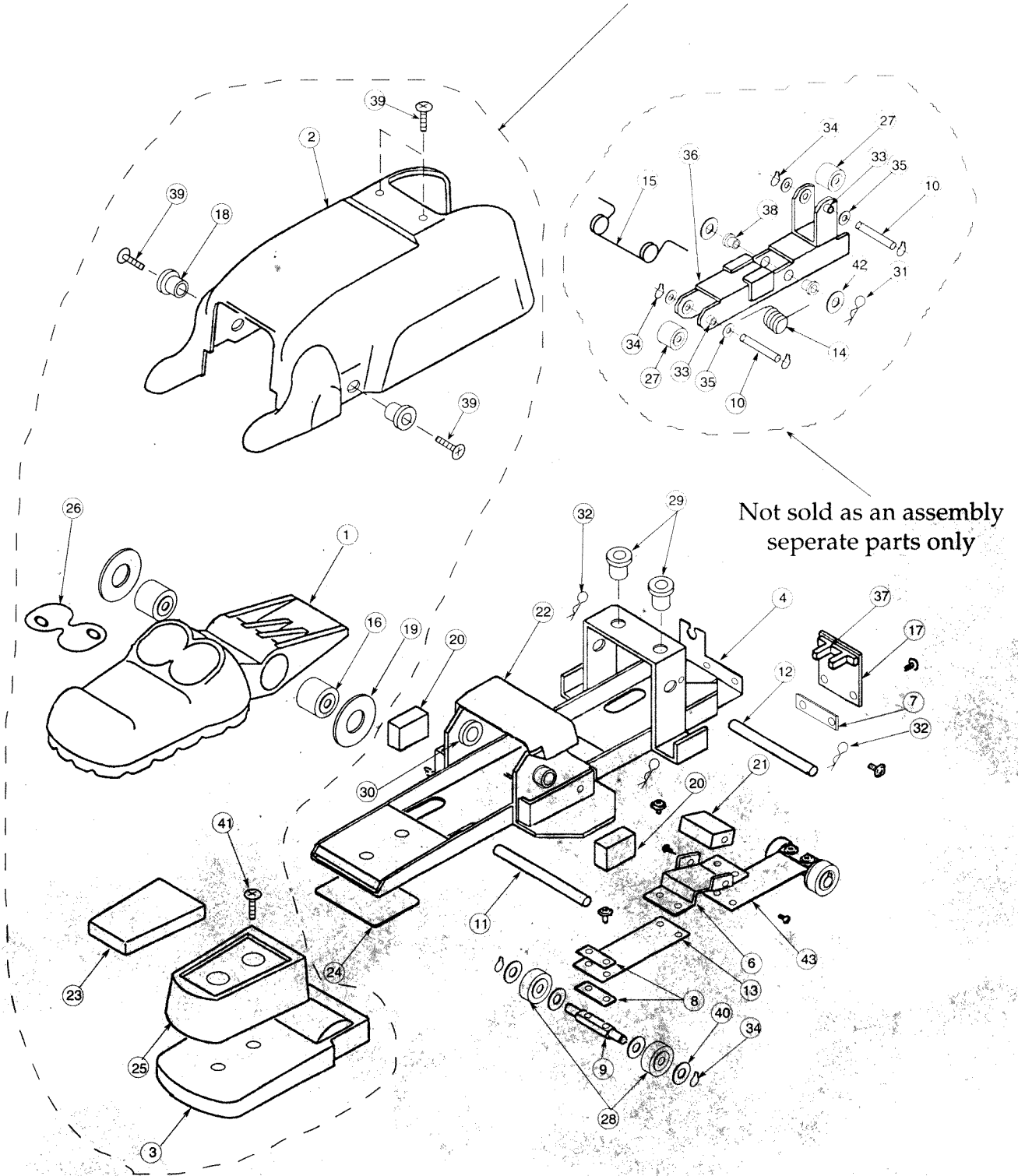

FRONT VIEW

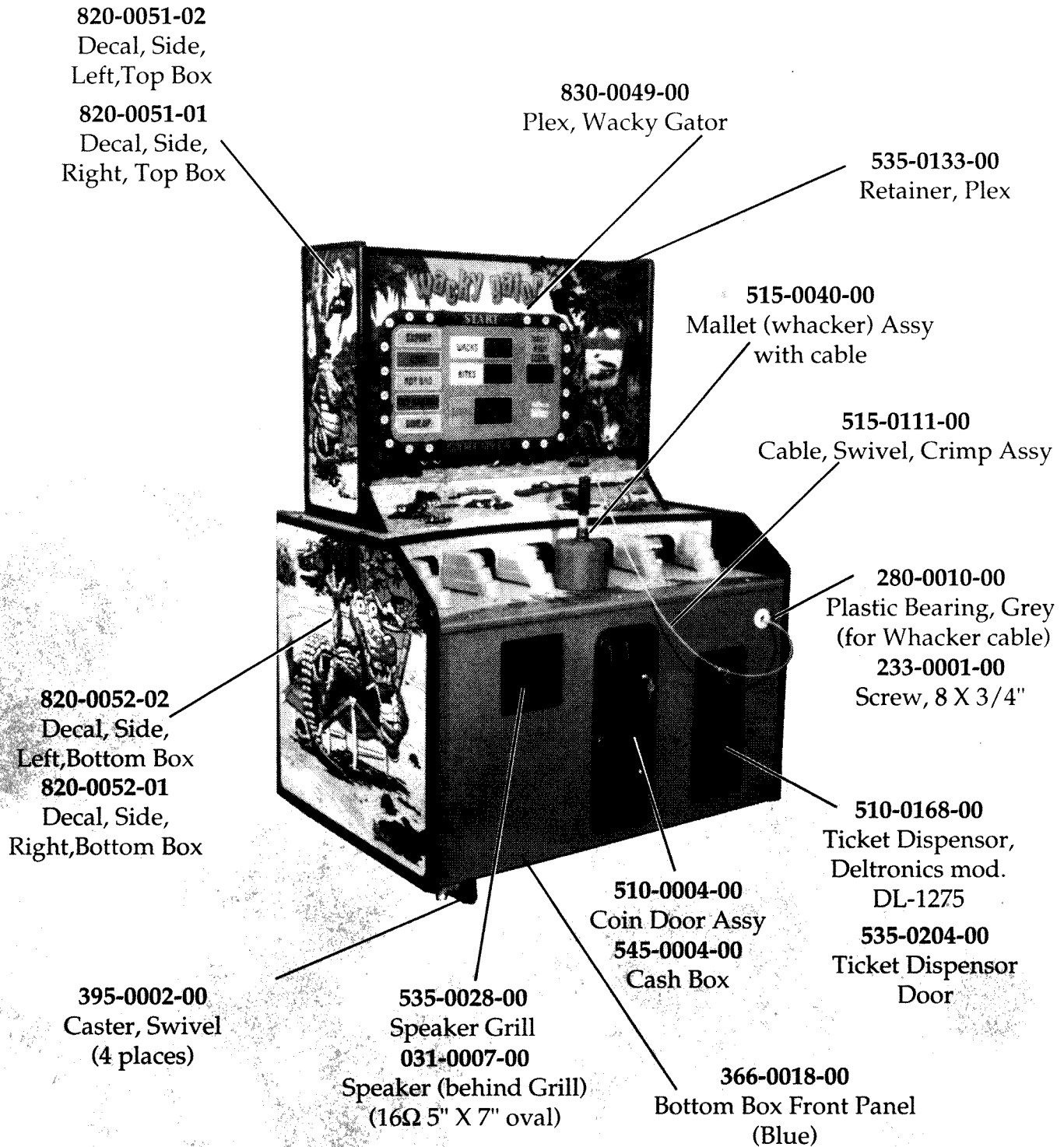

515-0052-00 – SHADOW BOX ASSEMBLY

077-5014-00
Socket, Lamp,
Shadow Box
165-0012-00
Lamp, 24V Sylvania type
24 MB

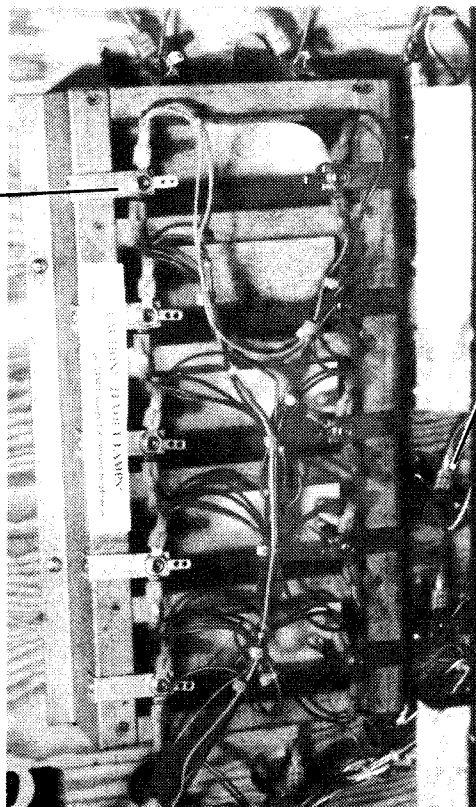

077-5009-00
Socket, Stand-up,
Miniature Bayonet
165-0011-00
Lamp, 28V, #1819

PLAYFIELD ASSEMBLY – 515-0054-00

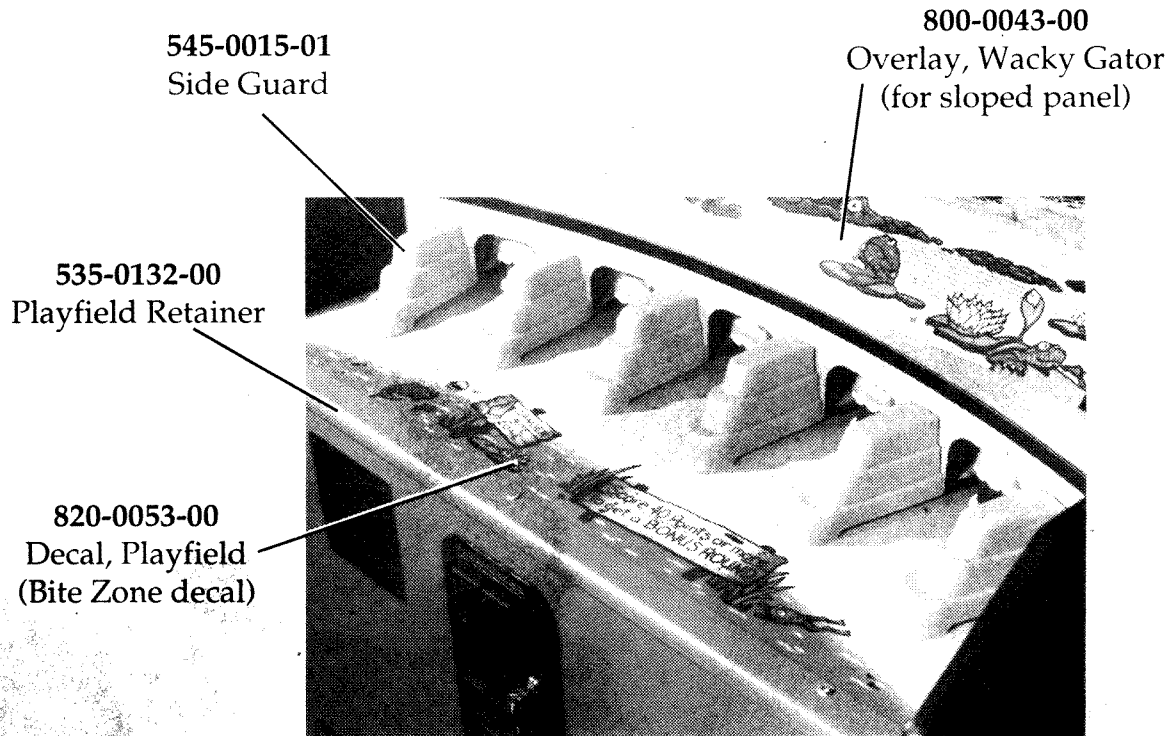

Not shown in photo

036-0204-00	Harness, (Drive & Character), (Red Dot)
036-0205-00	Harness, (Drive & Character), (Blue Dot)
036-0206-00	Harness, (Drive & Character), (No Dot)

SERVICE PANEL – 515-0057-00

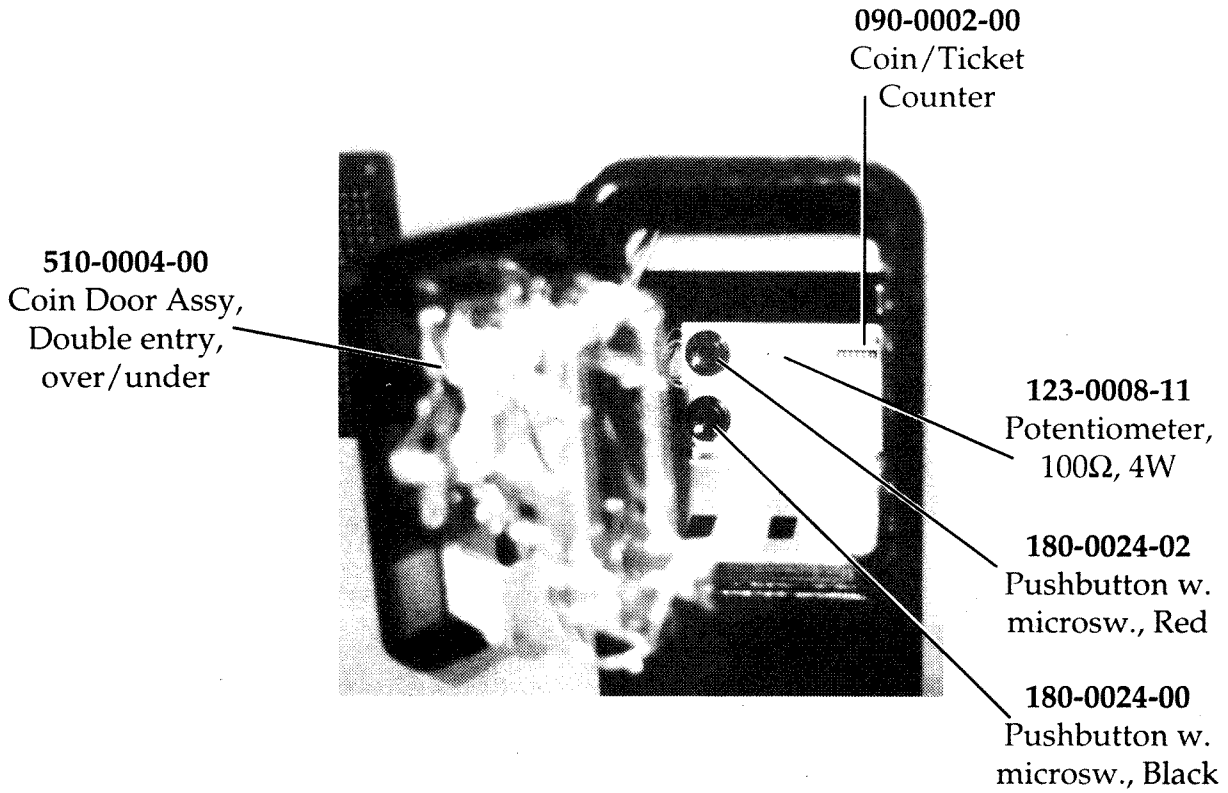

DISPLAY PCB – 510-0181-00

830-0050-00
Plex, Insert

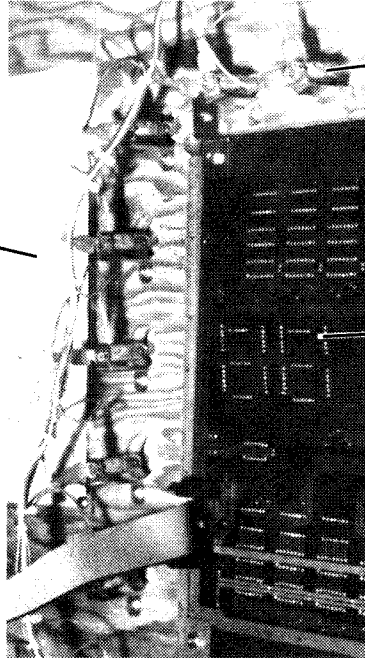

077-5009-00
Socket, Stand-up,
Miniature Bayonet
165-0012-00
Lamp, 28V, #1819

510-0181-00
Display PCB

GAME PCB – 510-0163-00

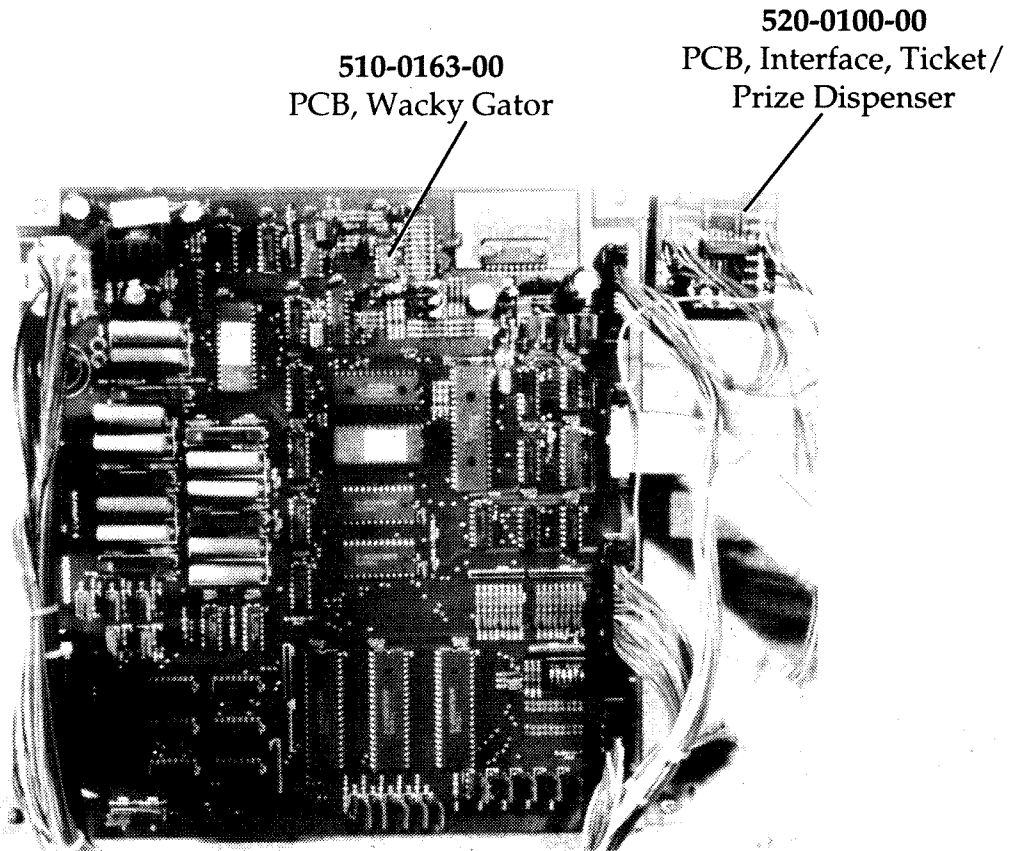

Not shown in photo

505-0012-00

Maintenance Connector - Wacky Gator

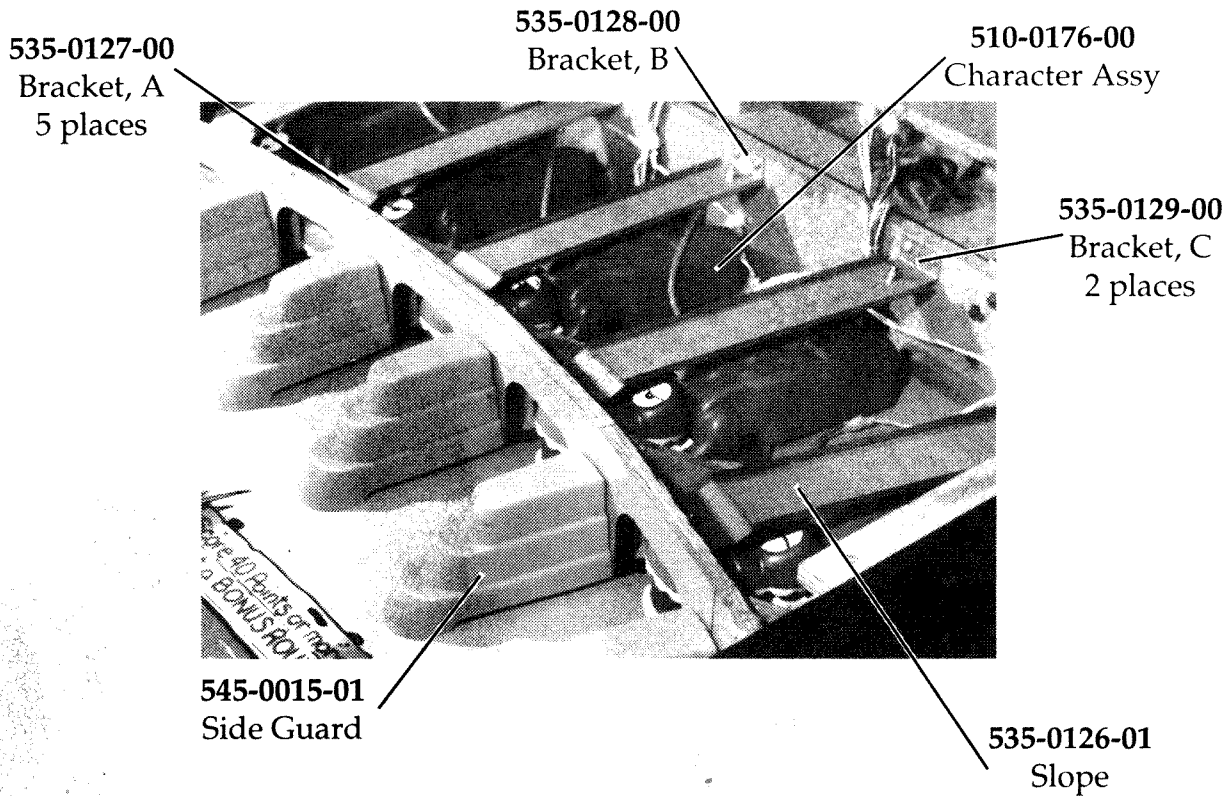

Not shown on photograph

535-0130-01	Bracket, D Left
535-0130-02	Bracket, D Right
231-0012-11	Bolt, 3/8" X 2-1/4"
242-0014-00	Washer, 3/8" ID, 5/8" OD
244-0008-00	Washer, 3/8" Split Lock

NOTE: There are 5 different brackets attaching the rear ends of the Slopes to the Bottom Box; the outermost brackets are **Bracket, D Left** and **Bracket, D Right**, respectively. The next inner brackets are identical, **Bracket C**, and the center one is **Bracket B**. All five front brackets are **Bracket A**.

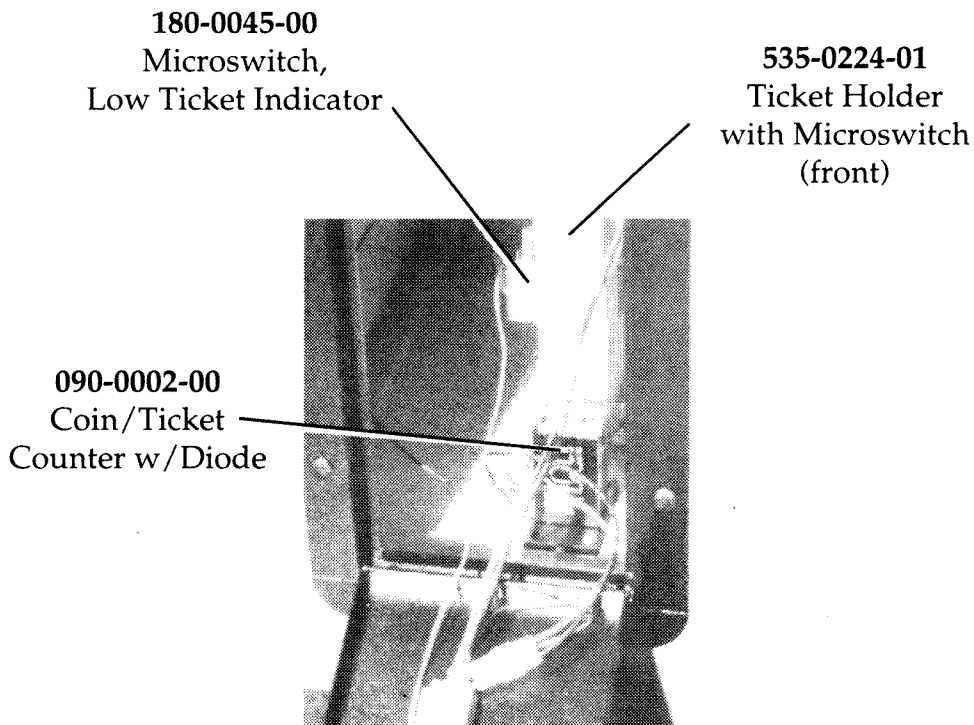

Not shown on photograph

- | | |
|-------------|---|
| 535-0224-00 | Ticket Holder (rear) |
| 165-0017-00 | LED, Red, PL519-1R (on door) |
| 120-0001-03 | Resistor, film, 1 kΩ, 1/4 watt, 5% (on LED) |

This page intentionally left blank

wacky gator

WIRING DIAGRAMS

Appendix B
Wiring Diagrams

POWER SUPPLY WIRING DIAGRAM – 510-0178-00

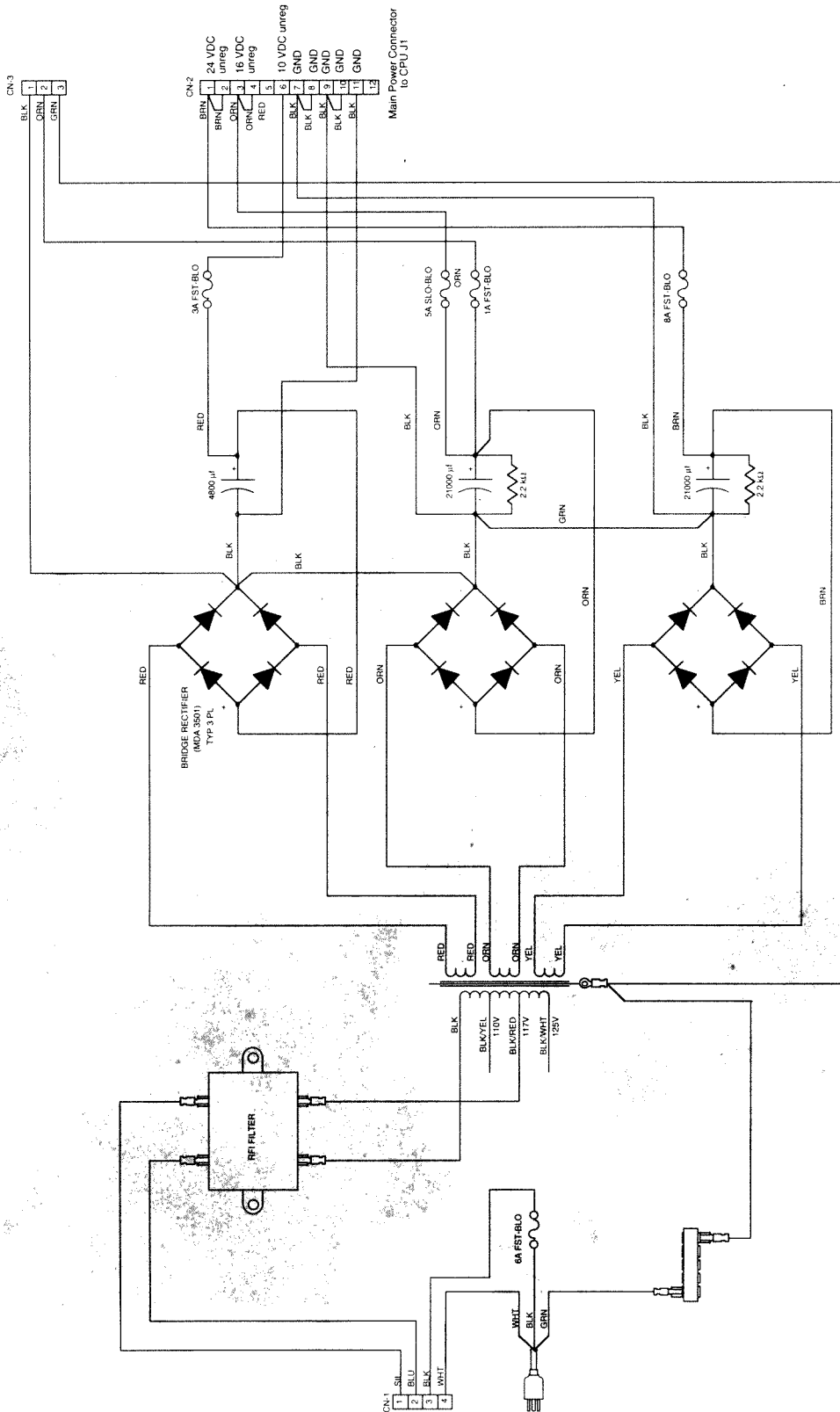

TIMING LIGHTS WIRING DIAGRAM

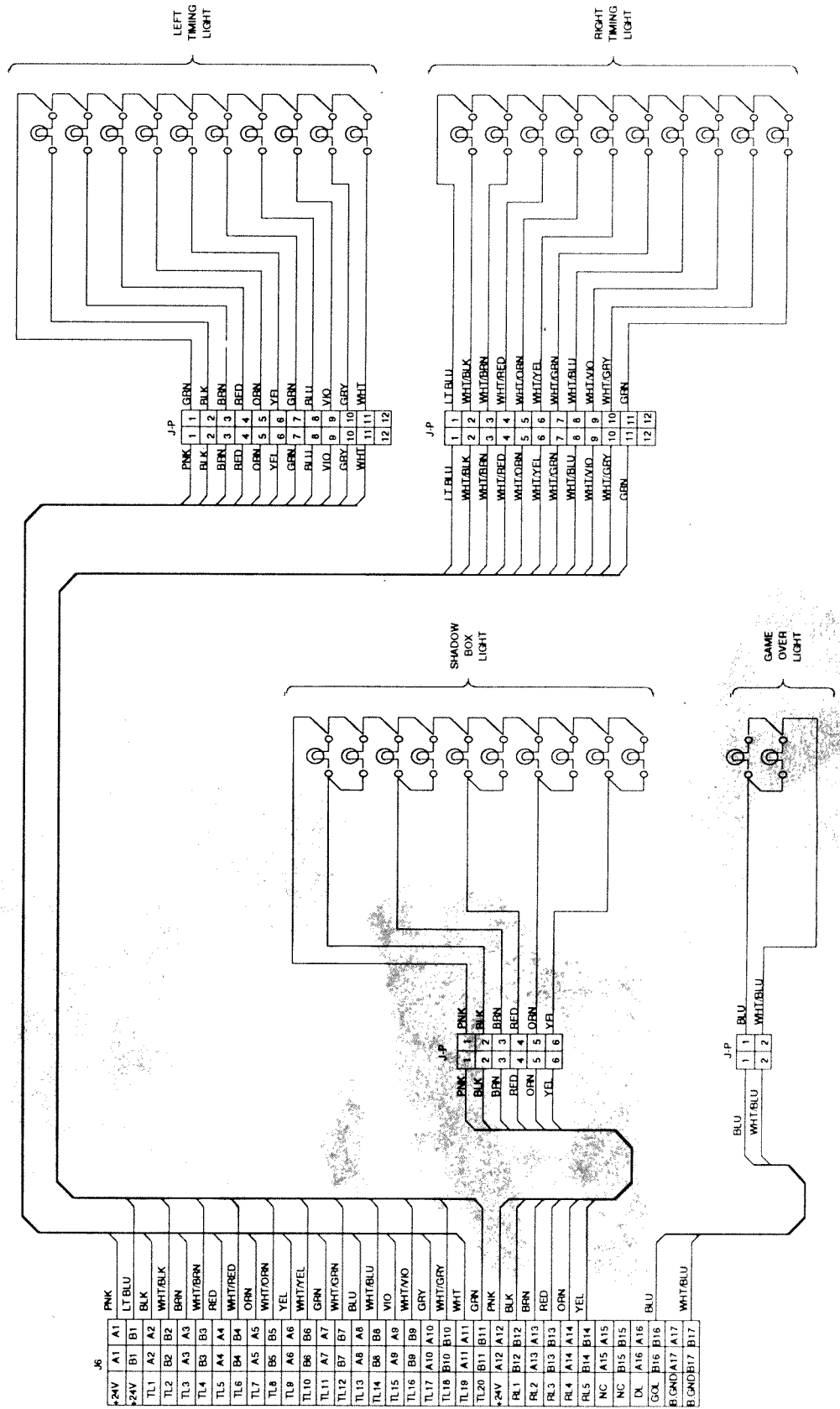

SERVICE/TICKET/PRIZE WIRING DIAGRAM

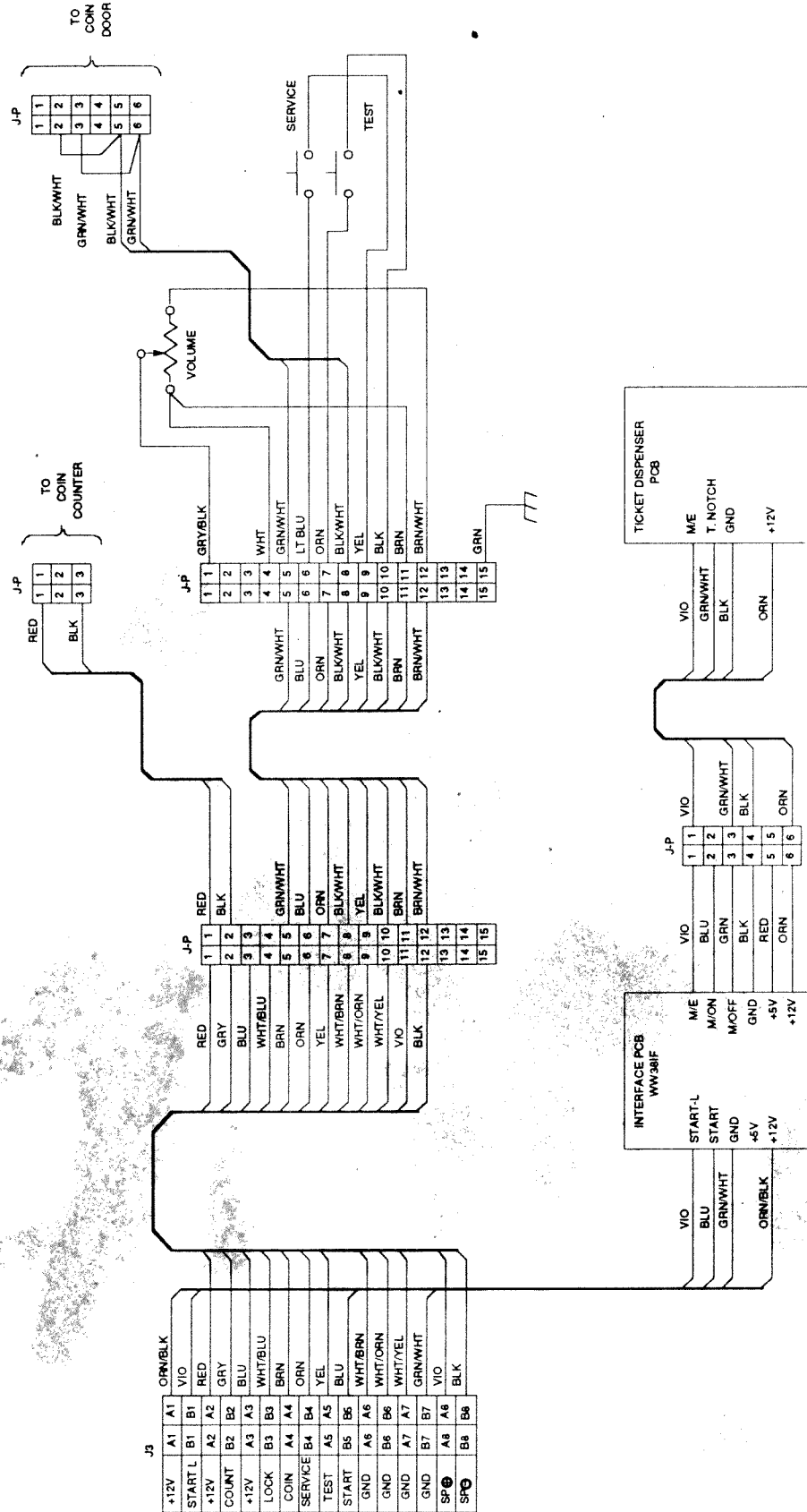

CHARACTER/DRIVE ASSY WIRING DIAGRAM

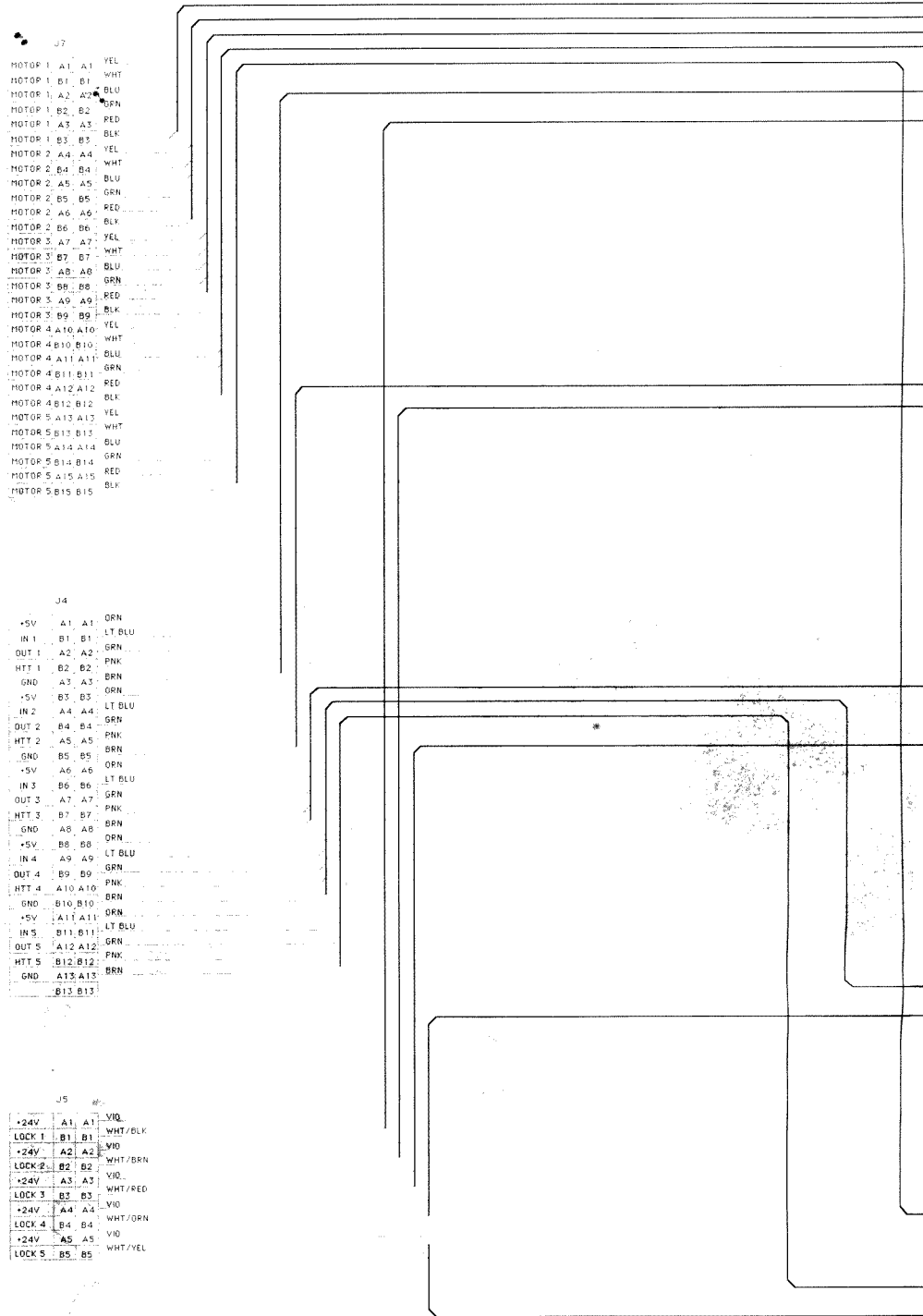

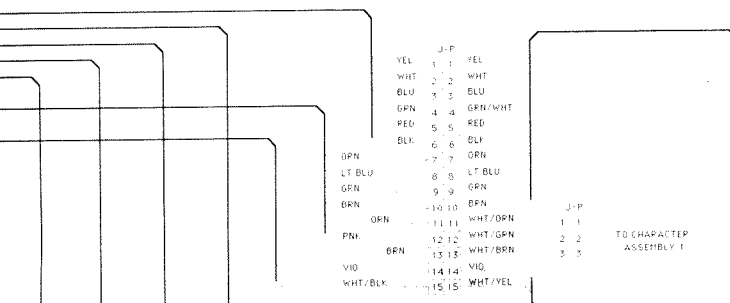

J-P	YEL	1 1	YEL
	WHT	2 2	WHT
	BLU	3 3	BLU
	GRN	4 4	GRN/WHT
	RED	5 5	RED
	BLK	6 6	BLK
OPN	7 7	OPN	
LT BLU	8 8	LT BLU	
GRN	9 9	GRN	
BRN	10 10	BRN	
OPN	11 11	WHT/OPN	
PNK	12 12	WHT/GRN	
BRN	13 13	WHT/BRN	
VIO	14 14	VIO	
WHT/BLK	15 15	WHT/YEL	

J-P	YEL	1 1	YEL
	WHT	2 2	WHT
	BLU	3 3	BLU
	GRN/WHT	4 4	GRN
	RED	5 5	RED
	BLK	6 6	BLK
OPN	7 7	OPN	
LT BLU	8 8	LT BLU	
GRN	9 9	GRN	
BRN	10 10	BRN	
VIO	11 11	VIO	
WHT/YEL	12 12	WHT/YEL	

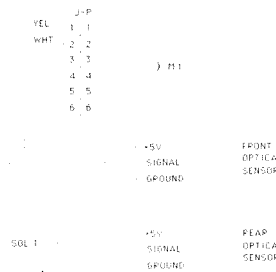

J-P	YEL	1 1	YEL
	WHT	2 2	WHT
	BLU	3 3	BLU
	GRN	4 4	GRN
	RED	5 5	RED
	BLK	6 6	BLK
OPN	7 7	OPN	
LT BLU	8 8	LT BLU	
GRN	9 9	GRN	
BRN	10 10	BRN	
VIO	11 11	VIO	
WHT/YEL	12 12	WHT/YEL	



J-P	YEL	1 1	YEL
	WHT	2 2	WHT
	BLU	3 3	BLU
	GRN/WHT	4 4	GRN
	RED	5 5	RED
	BLK	6 6	BLK
OPN	7 7	OPN	
LT BLU	8 8	LT BLU	
GRN	9 9	GRN	
BRN	10 10	BRN	
VIO	11 11	VIO	
GRN/WHT	12 12	GRN/WHT	

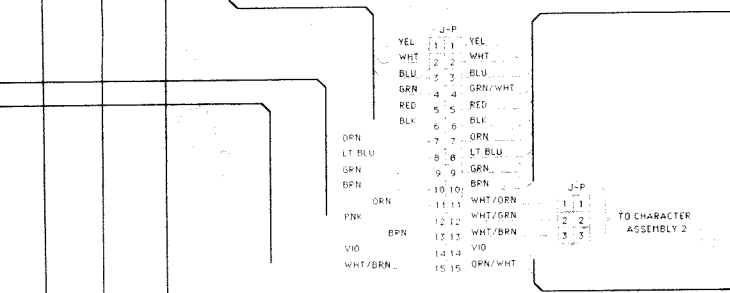

J-P	YEL	1 1	YEL
	WHT	2 2	WHT
	BLU	3 3	BLU
	GRN	4 4	GRN/WHT
	RED	5 5	RED
	BLK	6 6	BLK
OPN	7 7	OPN	
LT BLU	8 8	LT BLU	
GRN	9 9	GRN	
BRN	10 10	BRN	
OPN	11 11	WHT/OPN	
PNK	12 12	WHT/GRN	
BRN	13 13	WHT/BRN	
VIO	14 14	VIO	
WHT/BRN	15 15	OPN/WHT	

J-P	YEL	1 1	YEL
	WHT	2 2	WHT
	BLU	3 3	BLU
	GRN/WHT	4 4	GRN
	RED	5 5	RED
	BLK	6 6	BLK
OPN	7 7	OPN	
LT BLU	8 8	LT BLU	
GRN	9 9	GRN	
BRN	10 10	BRN	
VIO	11 11	VIO	
GRN/WHT	12 12	GRN/WHT	

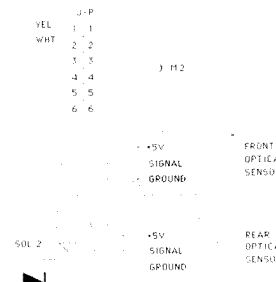

J-P	YEL	1 1	YEL
	WHT	2 2	WHT
	BLU	3 3	BLU
	GRN/WHT	4 4	GRN
	RED	5 5	RED
	BLK	6 6	BLK
OPN	7 7	OPN	
LT BLU	8 8	LT BLU	
GRN	9 9	GRN	
BRN	10 10	BRN	
VIO	11 11	VIO	
RED/WHT	12 12	RED/WHT	

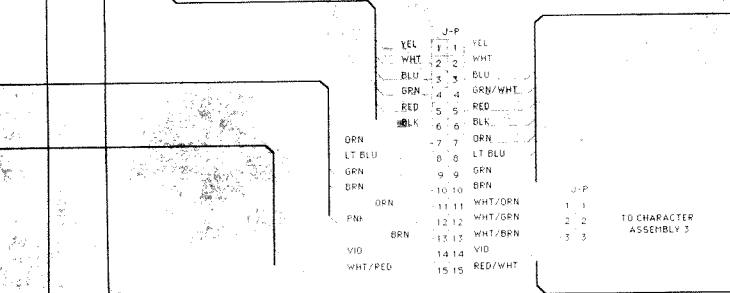

J-P	YEL	1 1	YEL
	WHT	2 2	WHT
	BLU	3 3	BLU
	GRN	4 4	GRN/WHT
	RED	5 5	RED
	BLK	6 6	BLK
OPN	7 7	OPN	
LT BLU	8 8	LT BLU	
GRN	9 9	GRN	
BRN	10 10	BRN	
OPN	11 11	WHT/OPN	
PNK	12 12	WHT/GRN	
BRN	13 13	WHT/BRN	
VIO	14 14	VIO	
WHT/RED	15 15	RED/WHT	

J-P	YEL	1 1	YEL
	WHT	2 2	WHT
	BLU	3 3	BLU
	GRN/WHT	4 4	GRN
	RED	5 5	RED
	BLK	6 6	BLK
OPN	7 7	OPN	
LT BLU	8 8	LT BLU	
GRN	9 9	GRN	
BRN	10 10	BRN	
VIO	11 11	VIO	
RED/WHT	12 12	RED/WHT	

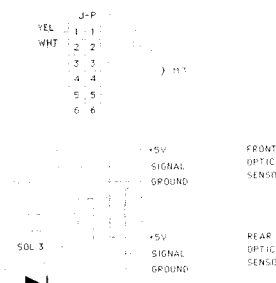

J-P	YEL	1 1	YEL
	WHT	2 2	WHT
	BLU	3 3	BLU
	GRN/WHT	4 4	GRN
	RED	5 5	RED
	BLK	6 6	BLK
OPN	7 7	OPN	
LT BLU	8 8	LT BLU	
GRN	9 9	GRN	
BRN	10 10	BRN	
VIO	11 11	VIO	
GRN/WHT	12 12	GRN/WHT	

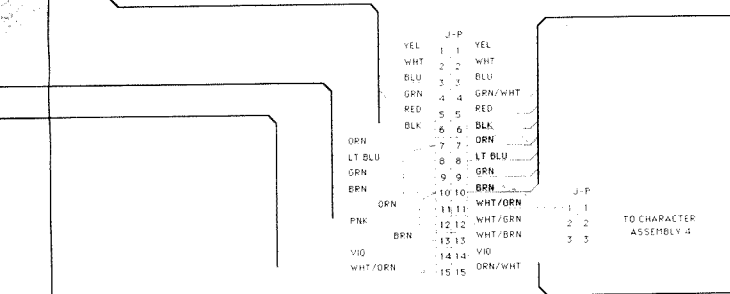

J-P	YEL	1 1	YEL
	WHT	2 2	WHT
	BLU	3 3	BLU
	GRN	4 4	GRN/WHT
	RED	5 5	RED
	BLK	6 6	BLK
OPN	7 7	OPN	
LT BLU	8 8	LT BLU	
GRN	9 9	GRN	
BRN	10 10	BRN	
OPN	11 11	WHT/OPN	
PNK	12 12	WHT/GRN	
BRN	13 13	WHT/BRN	
VIO	14 14	VIO	
WHT/OPN	15 15	OPN/WHT	

J-P	YEL	1 1	YEL
	WHT	2 2	WHT
	BLU	3 3	BLU
	GRN/WHT	4 4	GRN
	RED	5 5	RED
	BLK	6 6	BLK
OPN	7 7	OPN	
LT BLU	8 8	LT BLU	
GRN	9 9	GRN	
BRN	10 10	BRN	
VIO	11 11	VIO	
OPN/WHT	12 12	OPN/WHT	

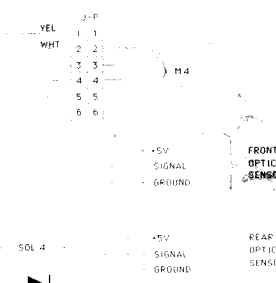

J-P	YEL	1 1	YEL
	WHT	2 2	WHT
	BLU	3 3	BLU
	GRN/WHT	4 4	GRN
	RED	5 5	RED
	BLK	6 6	BLK
OPN	7 7	OPN	
LT BLU	8 8	LT BLU	
GRN	9 9	GRN	
BRN	10 10	BRN	
VIO	11 11	VIO	
WHT/YEL	12 12	WHT/YEL	

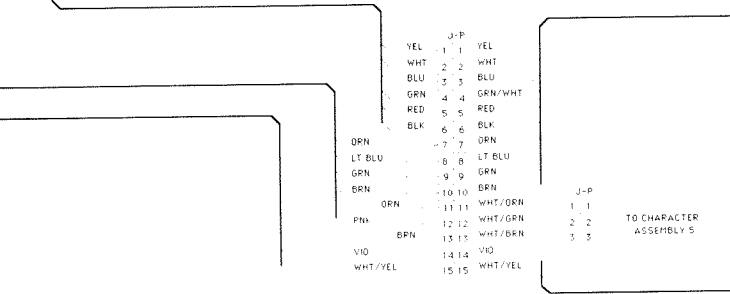

J-P	YEL	1 1	YEL
	WHT	2 2	WHT
	BLU	3 3	BLU
	GRN	4 4	GRN/WHT
	RED	5 5	RED
	BLK	6 6	BLK
OPN	7 7	OPN	
LT BLU	8 8	LT BLU	
GRN	9 9	GRN	
BRN	10 10	BRN	
OPN	11 11	WHT/OPN	
PNK	12 12	WHT/GRN	
BRN	13 13	WHT/BRN	
VIO	14 14	VIO	
WHT/YEL	15 15	WHT/YEL	

J-P	YEL	1 1	YEL
	WHT	2 2	WHT
	BLU	3 3	BLU
	GRN/WHT	4 4	GRN
	RED	5 5	RED
	BLK	6 6	BLK
OPN	7 7	OPN	
LT BLU	8 8	LT BLU	
GRN	9 9	GRN	
BRN	10 10	BRN	
VIO	11 11	VIO	
WHT/YEL	12 12	WHT/YEL	

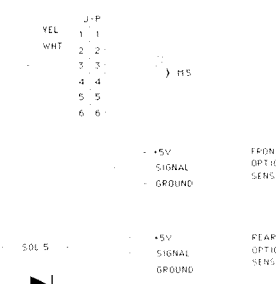

J-P	YEL	1 1	YEL
	WHT	2 2	WHT
	BLU	3 3	BLU
	GRN/WHT	4 4	GRN
	RED	5 5	RED
	BLK	6 6	BLK
OPN	7 7	OPN	
LT BLU	8 8	LT BLU	
GRN	9 9	GRN	
BRN	10 10	BRN	
VIO	11 11	VIO	
WHT/YEL	12 12	WHT/YEL	

WARRANTY INFORMATION

DATA EAST USA, INC, ("Seller"), warrants to the original purchaser ("Buyer"), of its products that the terms listed below are free from defects in materials and workmanship under normal use and service for the period specified:

GAME LOGIC PRINTED CIRCUIT BOARD(S) 90 DAYS

No other parts of the Seller's products are warranted.

Warranty periods are effective from date of initial shipment from Seller to Buyer. Seller's sole liability shall be, at its option, to repair or replace products which are returned to Seller during the warranty period specified, provided:

1. Seller is notified promptly upon discovery by buyer that stated products are defective.
2. Such products are properly packaged and then returned freight pre-paid, to a place specified by seller.

This warranty does not apply to products damaged during shipment and/or due to improper handling, or due to improper installation or usage, or alteration. In no event shall Seller be liable for any anticipated profits, loss of profits, loss of use, accidental or consequential damages, or any other losses incurred in connection with the purchase of a Data East USA, Inc. product.

Except as specifically provided in a written contract between seller and buyer, there are no other warranties, expressed or implied, including any implied warranties of merchantability or fitness for a particular purpose.

Data East USA, Inc.
1850 Little Orchard Dr.
San Jose, CA 95125-1045
Tele: (408) 286-7080
Fax: (408) 971-0722

