



KONAMI®



TURTLES IN TIME™

TEENAGE MUTANT NINJA TURTLES
All rights reserved. © Mirage Studios, USA
under license granted to Konami
TURTLES IN TIME
© Konami Inc. 1991
Mirage Studios, USA
Trademark of Konami Inc.
Trademark of Konami Co., Ltd.

Service #

708-215-5100

Jerry Korbecki ext. 122

INSTRUCTION MANUAL

KONAMI® is a trademark of Konami Industry Co., Ltd.

T.M.N.T. II PARTS LIST

Part #	Description
063003	T.M.N.T. II P.C.B.
063100	T.M.N.T. II C.P.O.
063101	T.M.N.T. II Player Instruction
063200	T.M.N.T. II Marquee
063300	T.M.N.T. II Upper Right Side Decal
063301	T.M.N.T. II Upper Left Side Decal
063302	T.M.N.T. II Middle Right Side Decal
063303	T.M.N.T. II Middle Left Side Decal
063304	T.M.N.T. II Lower Right Side Decal
063305	T.M.N.T. II Lower Left Side Decal
063306	T.M.N.T. II P.O.P. Advertiser
063400	T.M.N.T. II Manual (4P)
40905	3 & 4 Player Harness
40901	Speaker Harness
40605	FCC Cage
40615	Kit Box
# N/A	Red Joy Stick (Microswitch)
# N/A	Blue Joy Stick (Microswitch)
# N/A	Violet Joy Stick (Microswitch)
# N/A	Orange Joy Stick (Microswitch)
30263	Red Jump Button
30264	Red Attack Button
30265	Blue Jump Button
30266	Blue Attack Button
30269	Violet Jump Button
30270	Violet Attack Button
30267	Orange Jump Button
30268	Orange Attack Button
30261	Microswitch
30262	Palnut (Plastic)

PUTTING YOUR BEST GAME FORWARD

PREPARATION:

For best results, all old graphics should be removed completely from the cabinet. "Stick-on" graphics can be removed by using a hairdryer or hot air device. The heat from the dryer will loosen the adhesive, allowing you to easily peel them off—any adhesive residue can be cleaned off with acetone and a soft dry cloth. (DO NOT USE ACETONE ON SURFACES PAINTED WITH FLAT PAINT.)

TOOLS YOU NEED:

1. Foaming Aerosol (such as "Windex").
2. Soft Squeegee.
3. X-Acto Knife.

SIDE PANEL DECALS

1. Spray area of cabinet where Side Panel decals are to be applied with foaming aerosol or a mild soap solution.
2. Remove protective backing from decals.
3. Position decals into place.
4. With a soft squeegee, beginning from the center of the decal, slowly and evenly press out excess foam until you achieve a smooth finish.
5. Allow to set approximately 2 to 3 hours before handling. Maximum adherence is achieved in 48 to 72 hours.

6. Trim side decal to fit your cabinet.

CONTROL PANEL OVERLAY:

1. Drill any new holes needed.
2. Plug any holes that will not be used. (A permanent epoxy-filler works well for this step.)
3. Pre-position the overlay prior to removing the backing.
4. Slowly apply the overlay — inch by inch on the control panel, removing the backing as you apply it.
5. Once it's in place, by using an X-Acto knife, cut around the button and joystick placements.

INSTRUCTION/BUTTON DECALS:

Apply the Player Instruction, Button and 1 Player/2 Player decals in their respective positions. Apply pressure liberally. Allow to set as long as possible before putting game on location.

NOTE: Maximum adherence is achieved in 48 to 72 hours.

MARQUEE

(WEAR PROTECTIVE GLASSES WHILE TRIMMING MARQUEE)

1/8" Acrylic Marquee should be cut to fit your game. DO NOT remove protective mask until this is done.

One way of cutting your Marquee is as follows: (Be sure to protect painted side of Marquee from any surface which may scratch or mar finish).

CUTTING WITH A KNIFE OR SCRIBER:

Acrylic sheet up to 3/16" thick may be cut by a method similar to that used for cutting window glass. Use a scriber of some kind — a scribing knife such as the one pictured, a metal scriber, an awl, or even a sturdy craft knife — to score the sheet. Draw the scriber several times (7 or 8 times for a 3/16" thick piece) along a straight edge held firmly in place. It is best not to remove the protective masking. Make the cuts carefully using firm, even pressure. For best results make each stroke cleanly off the edge of the sheet.

Then clamp the acrylic sheet or hold it rigidly under a straight edge with the scribe mark hanging just over the edge of a table. Protect your hands with a cloth, and apply a sharp downward pressure to the other side of the sheet. It will break along the scratch. Scrape the edges to smooth any sharp corners. This method is not recommended for long breaks or thick material.

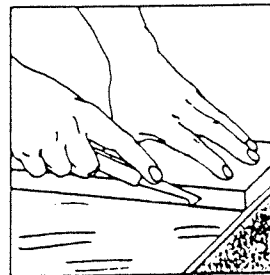

Always draw the scribing knife along a straight edge.

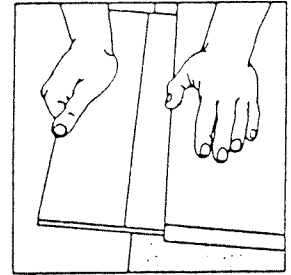

Break sheet over edge of table after scribing.

P.C.B. CAGE INSTALLATION

Konami, Inc. now supplies a new style P.C.B. cage which is superior to old style cages because of ease of installation. The cage is made of a 32 point stem-stock which is fire retardant.

TO INSTALL THE CAGE:

1. Open cage bottom and secure to desired P.C.B. position.
2. Install printed circuit board inside cage using wood screws, screwed through the cage bottom into cabinet side.
3. Close the cage over printed circuit board and secure with latch on cage.

T.M.N.T. II TECHNICAL INFORMATION

T.M.N.T. II requires horizontally mounted monitor. It also generates composite negative sync. If your monitor is composite positive sync, you will have to change to composite negative sync.

To alternate composite positive sync to composite negative sync, use 7404 IC or 74LS04 IC. The signal on the output pin from the P.C.B. is a combination of H-sync and V-sync.

NOTE: Please refer to Figure 2.

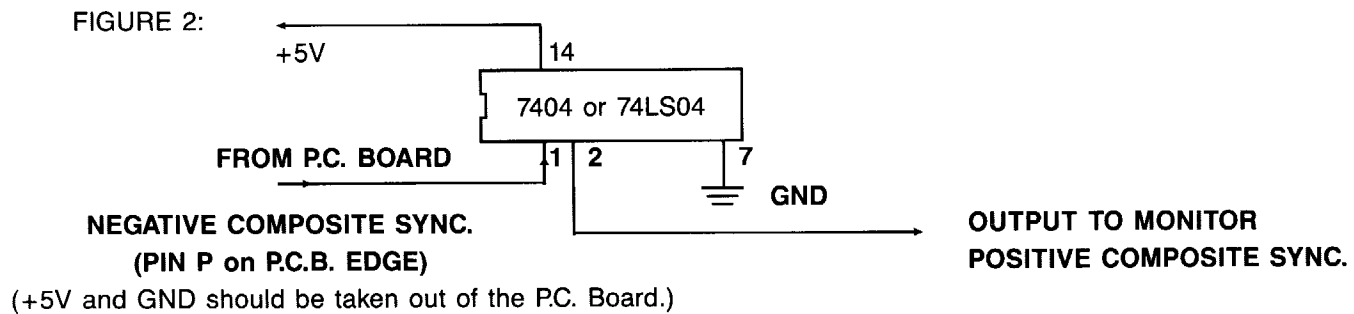

TROUBLE SHOOTING GUIDE

PROBLEM:	POSSIBLE SOLUTION
No Screen or Constant Reset	<ol style="list-style-type: none"> 1). Check +5V line at the P.C.B. Adjust if necessary. 2). Make sure all socketed eproms and custom IC's are seated securely. Apply light pressure to secure. 3). Check harness to be sure it is not on backwards.
No Sound	<ol style="list-style-type: none"> 1). Check +12V line at the P.C.B. 2). Make sure both speaker out wires are connected to the speakers. (DO NOT CONNECT A GROUND.)
Distorted Sound	<ol style="list-style-type: none"> 1). Replace cabinet speaker.
I/O Problem (coin 1 doesn't work or Joystick Up doesn't work, etc.)	<ol style="list-style-type: none"> 1). Do not hook a coin counter to the coin 1 or coin 2 outputs. This will cause damage. 2). Check your schematic for the 74LS253 IC that corresponds to your I/O problem. Check the appropriate pin with a scope or multimeter for a high output (5V), if output is low replace the 74LS253.

CAUTION

DO NOT WIRE COIN COUNTERS TO THE COIN 1 OR COIN 2 OUTPUTS. THIS WILL CAUSE DAMAGE TO THE I/O MICROCHIP 74LS253. COIN COUNTERS CAN ONLY BE WIRED TO COIN COUNTER OUTPUTS.

T.M.N.T. II MONITOR INFORMATION

SERVICE INSTRUCTIONS

NOTE: All monitors are equipped with automatic degaussing coils (L701) which demagnetize the picture tube every time the monitor is turned on after being off for a minimum of 5 minutes. Should any part of the chassis become magnetized it will be necessary to degauss the affected area with a manual degaussing coil. Move the coil slowly around the CRT face and all surrounding metal parts. Then slowly withdraw for a distance of 6 feet before turning off.

1.0 BLACK LEVEL CONTROL ADJUSTMENT

This control has been set at the factory and should not need further attention, however, when the game is connected a slight adjustment of VR201 may be necessary to obtain the proper black level (the black portion of the picture just extinguished).

2.0 VERTICAL SIZE (HEIGHT)

Location of this control is shown in Fig. 1. This control must be adjusted slowly, if necessary, until the picture or test pattern attains the correct vertical proportions.

3.0 CIRCUIT PROTECTION

A 4.0A pigtail fuse, mounted on the Main Board has been provided to protect the Power Output Circuit.

4.0 FOCUS

Adjust the focus control, located on the HV unit (T352), for maximum over-all definition and fine picture detail.

5.0 HORIZONTAL HOLD CONTROL ADJUSTMENT, VR351 (See Fig. 1)

A warm-up period of at least five minutes should be allowed before alignment is carried out. With the monitor being driven from the game signal, short TP601 to TP31. Adjust VR351 until the picture stops sliding horizontally. Remove the short.

6.0 HORIZONTAL VIDEO POSITION

If the video is off center on the raster some compensation can be made by adjusting this control.

7.0 VERTICAL RASTER POSITION ADJUSTMENT

If the video is off center vertically, (short dimension of picture tube) some compensation can be made by moving the vertical raster position adjustment jumper to either positions "U" or "D".

8.0 HORIZONTAL RASTER POSITION ADJUSTMENT

If the video is off center horizontally (long dimension of the picture tube) some compensation can be made by moving the horizontal raster position adjustment jumper to either positions "R" or "L".

9.0 HORIZONTAL WIDTH ADJUSTMENT

The horizontal width coil is a hexagonal tuning tool adjustment. This control must be adjusted slowly, if necessary, until the picture or test pattern attains the correct horizontal proportions.

* KONAMI GAMES ARE ALL NEGATIVE COMPOSITE SYNC. USE THE THREE PIN CONNECTOR ON THE MONITOR.

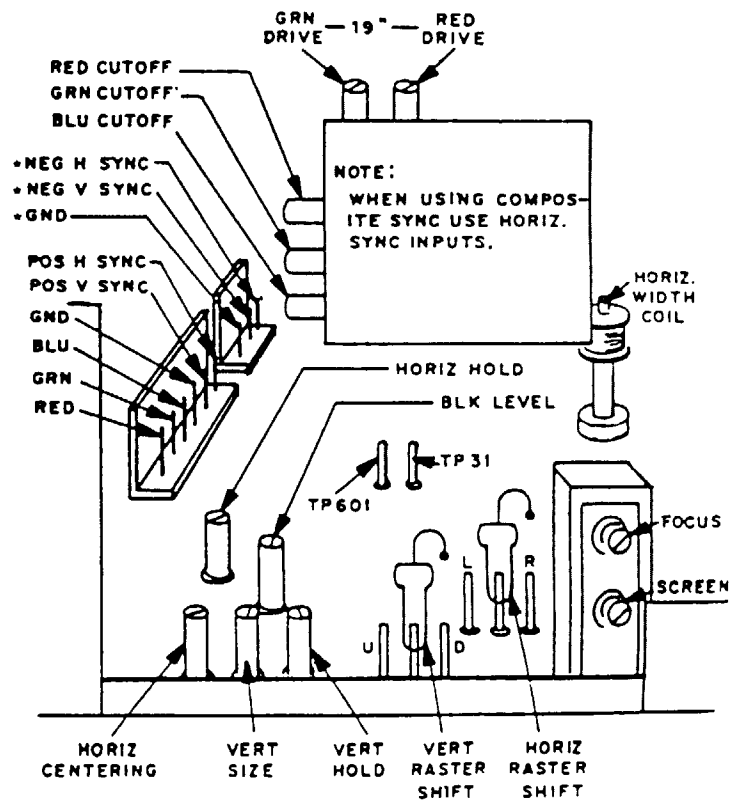

FIGURE 1

T.M.N.T. II TECHNICAL INFORMATION

TECHNICAL INFORMATION

- (1) Required power capacity
GND-Vcc 5V 4A or more
GND-(+12V)
*See the Wiring Diagram.
- (2) Output
R (red) analog, positive
G (green) analog, positive
B (blue) analog, positive
SYNC. H-V complexed, negative
- (3) The monitor should be horizontally installed.
- (4) Use the volume knob on the PCB to adjust sound level.
Turn the knob clockwise for increased volume. In monaural output mode, use the left volume knob.
- (5) Handle with care.

PLAY INSTRUCTION

- 1 to 4 players can play at the same time.
- Choose the character you want to control out of the four individual Ninja Turtles: LEONARDO (Weapon: Katana), MICHAELANGELO (Nunchaku), DONATELLA (Bo staff), or Raphael (pair of sai).
- Deposit coins into the coin slot of the character you want and press ATTACK or JUMP button to start.
- Control your character's movement using the 8-way joystick and attack enemies with ATTACK button. Press ATTACK button repeatedly to slice, slash, hurl, kick, thrust the enemies. Use JUMP button to avoid enemy attack or defeat enemies in the air. Pressing JUMP button longer makes higher jump.
- Press ATTACK and JUMP buttons simultaneously for a powerful Special Attack according to the individuality of each character.
- Press JUMP button while in the air for a flying kick or slash.
- Keep pressing JOYSTICK to run left or right. Press ATTACK button while running to tackle enemies or make a sliding attack.
- Pick up a piece of pizza to fully restore your energy or to make a revolving attack.
- Your energy will be consumed when attacked by enemies. When it is used up, you will lose one life. The game is over when you have lost all the lives.
- There are 9 stages in all. You can continue the game as many times as you want. Any player can join at any time.

CABINET INFORMATION

- (1) Use a multi control upright cabinet with four sets of an 8-way joystick and two function buttons.
- (2) Four independent coin slots are necessary. Start buttons are substituted by the function buttons for each player.



8-WAY
JOYSTICK



ATTACK
BUTTON



JUMP
BUTTON

T.M.N.T. II TECHNICAL INFORMATION (cont.)

SELF TEST

Normal: "OK" will be displayed. Then the game will start.

Abnormal: "BAD" will be displayed and self test will repeat. If "15B BAD" is displayed, switch off and switch on again with TEST SWITCH (on the PCB) pressed.

MANUAL TEST

(1) HOW TO START

After switching on the power, press the TEST SWITCH on the PCB or on the cabinet, and you will get the MAIN MENU of the Manual Test.

NOTE: Switching on with TEST SWITCH pressed causes the program in the EEPROM to be initialized to default.

(2) HOW TO RETURN TO THE GAME MODE

Select "GAME MODE" on the MAIN MENU then press player 1 ATTACK button to return to the game mode.

(3) ITEMS AND HOW TO SELECT

Use player 1 JOYSTICK to move arrow to desired test and press 1 ATTACK button to initiate testing. Press player 1 ATTACK button during or at the end of each test to return to the MAIN MENU.

I/O CHECK
SCREEN CHECK
COLOR CHECK
SOUND CHECK
MASK ROM CHECK
GAME OPTIONS
COIN OPTIONS
GAME MODE

1PLYR JOYSTICK = SELECT ITEM
1PLYR ATTACK = DO CHECK

(4) EXPLANATION OF THE ITEMS

1. I/O CHECK

Check all the joysticks and buttons to see "1" when switched on. Press player 1 and 2 ATTACK buttons at the same time to return to MAIN MENU.

2. SCREEN CHECK

Adjust focus, alignment, size, etc. using the cross-hatch screen.

3. COLOR CHECK

Adjust color brightness so that the specified area will be colorless.

4. SOUND CHECK

When "SOUND SCALE CHECK" is selected, a music scale sounds. At "SOUND CODE," push player 1 JOYSTICK right/left to change sound code.

5. MASK ROM CHECK

Roms will be checked one after another, and the message "OK" or "BAD" will be displayed on the screen.

6. GAME OPTIONS

Following screen will appear. Use player 1 JOYSTICK up/down to select the item and push JOYSTICK right/left to modify setting. Factory settings are shown in green, and modified results in red. (Settings below are not always the factory settings.)

T.M.N.T. II TECHNICAL INFORMATION (cont.)

After modification is completed, select "SAVE AND EXIT" and press player 1 ATTACK button to save and return to MAIN MENU.

GAME OPTIONS	
PLAYER'S LIFE	1 CREDIT 2 LIVES
DIFFICULTY LEVEL	2/MEDIUM
VIDEO SCREEN FLIP	NORMAL
SOUND OUTPUT	MONAURAL
SOUND IN ATTRACT MODE	ON
LOOP SETTING	GAME LOOPS ENDLESSLY
FACTORY SETTINGS	
SAVE AND EXIT	
EXIT	
1PLYR JOYSTICK UP/DOWN=SELECT OPTION	
1PLYR JOYSTICK RIGHT/LEFT=MODIFY SETTING	

- ...Select from 1 to 8 lives.
- ...Select out of 4 levels.
- ... "NORMAL" or "UPSIDE DOWN"
- ... "STEREO" or "MONAURAL"
- ... "ON" or "OFF"
- ... "GAME OVER AFTER FINAL STAGE" or "GAME LOOPS ENDLESSLY"
- ... All the settings return to default.
- ... Save the modified settings.

*If you select "EXIT" instead of "SAVE AND EXIT" after modifying some settings, the message appears: "YOU DID NOT SAVE. DO YOU WANT TO SAVE? YES/NO." When you choose "YES," the screen shows "NOW SAVING" and returns to MAIN MENU. If you select "NO," "NO MODIFICATION" is shown and then MAIN MENU appears.

(7) COIN OPTIONS

Selecting this item, the screen shows following options.

COIN OPTIONS	
PREMIUM START	YES 1
STARTING	2 COINS 1 CREDIT
CONTINUATION	1 COIN 1 CREDIT
FACTORY SETTINGS	
SAVE AND EXIT	
EXIT	
1PLYR JOYSTICK UP/DOWN=SELECT OPTION	
1PLYR JOYSTICK RIGHT/LEFT=MODIFY SETTING	

- ... "NO" or "YES 1" to "YES 3"
- (The number means the EXTRA coins necessary)

} Same as above "GAME OPTIONS"

When you want "PREMIUM START" setting, choose the number of extra coins necessary for starting, then decide the coin setting for continuation. The number of coins for starting will be the sum of both numbers. If you do not want premium start setting, the number of coins necessary for starting and continuation will be the same.

*COIN SETTING OPTIONS

Coin(s)	1	1	1	1	1	1	1	2	2	2	3	3	3	4	4	4
Credit(s)	1	2	3	4	5	6	7	1	3	5	1	2	4	1	3	5

T.M.N.T. II SUB HARNESS FOR 3 PLAYERS & 4 PLAYERS

CN3 3P CONTROLS	1	Coin 3	Blue/White
	2	Empty	
	3	3P Left	White/Red
	4	3P Right	White/Yellow
	5	3P Up	White/Black
	6	3P Down	White/Blue
	7	3P Jump	White/Brown
	8	3P Attack	White/Orange
	9	Empty	
	10	Empty	
	11	Empty	
	12	Empty	
	13	Empty	
	14	Empty	
	15	Ground	Black

CN4 4P CONTROLS	1	Coin 4	Red/Green
	2	Empty	
	3	4P Left	Yellow/Black
	4	4P Right	Brown/Black
	5	4P Up	Green/Yellow
	6	4P Down	Yellow/Red
	7	4P Jump	Yellow/White
	8	4P Attack	Yellow/Blue
	9	Empty	
	10	Empty	
	11	Empty	
	12	Empty	
	13	Empty	
	14	Empty	
	15	Ground	Black

T.M.N.T. II WIRING HARNESS

*JAMMA HARNESS NOT SUPPLIED

Solder Side ← → Parts Side

GND	A	1	GND
GND	B	2	GND
+5V DC	C	3	+5V DC
+5V DC	D	4	+5V DC
NOT USED	E	5	NOT USED
+12V DC	F	6	+12V DC
*KEY	H	7	*KEY
(EMPTY)	J	8	COIN COUNTER
(EMPTY)	K	9	(EMPTY)
SPEAKER (-)	L	10	SPEAKER (+)
(EMPTY)	M	11	(EMPTY)
VIDEO GREEN	N	12	VIDEO RED
VIDEO SYNC	P	13	VIDEO BLUE
(EMPTY)	R	14	VIDEO GROUND
(EMPTY)	S	15	TEST SWITCH
COIN 2	T	16	COIN 1
NOT USED	U	17	NOT USED
2P UP	V	18	1P UP
2P DOWN	W	19	1P DOWN
2P LEFT	X	20	1P LEFT
2P RIGHT	Y	21	1P RIGHT
2P ATTACK	Z	22	1P ATTACK
2P JUMP	a	23	1P JUMP
NOT USED	b	24	NOT USED
NOT USED	c	25	NOT USED
NOT USED	d	26	NOT USED
GND	e	27	GND
GND	f	28	GND

(BASE COLOR/LINE COLOR)

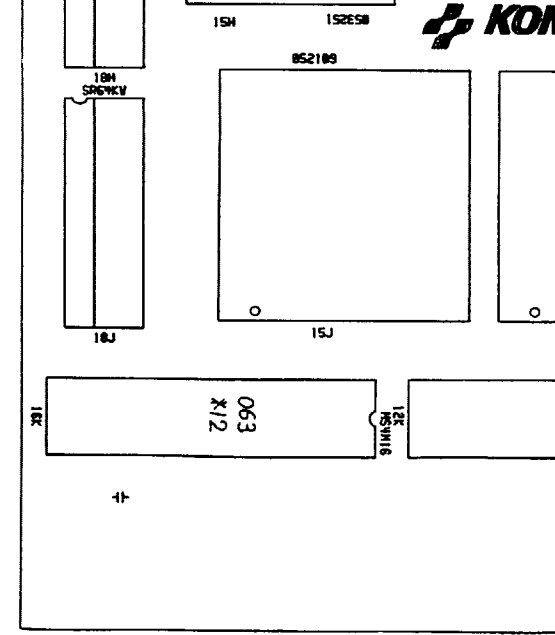
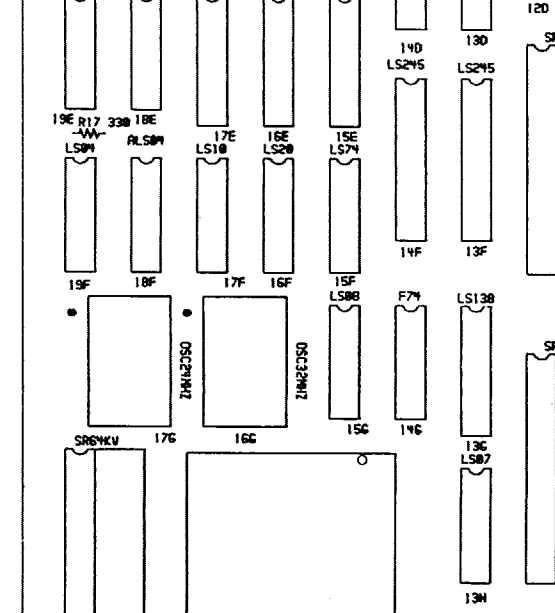
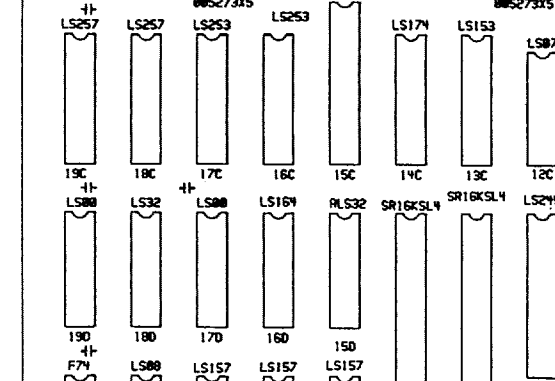
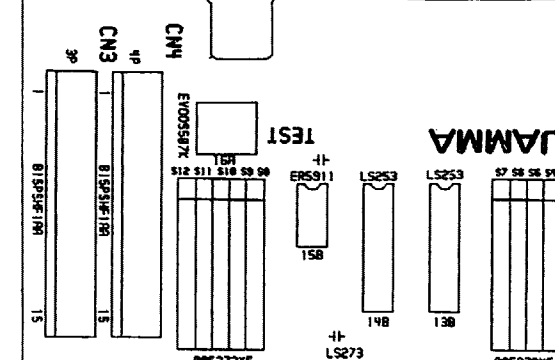
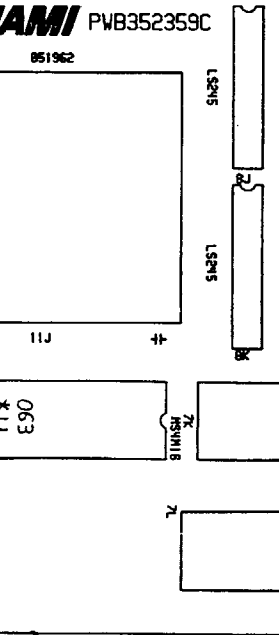
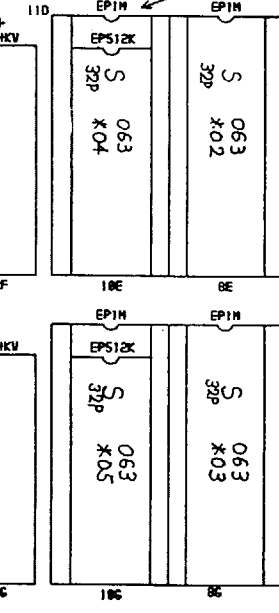
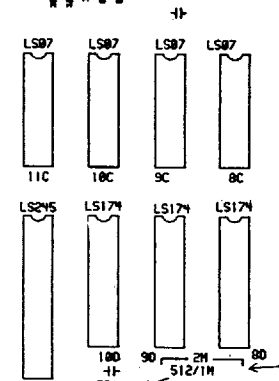
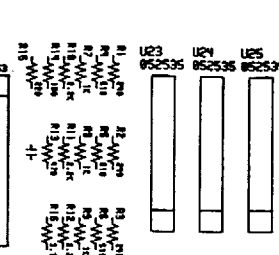
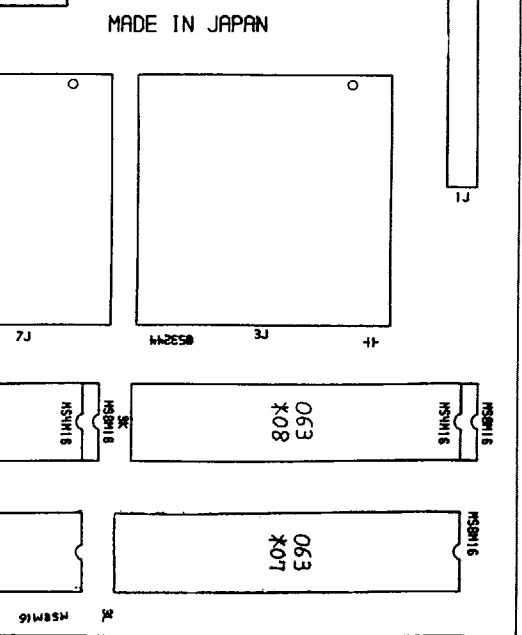
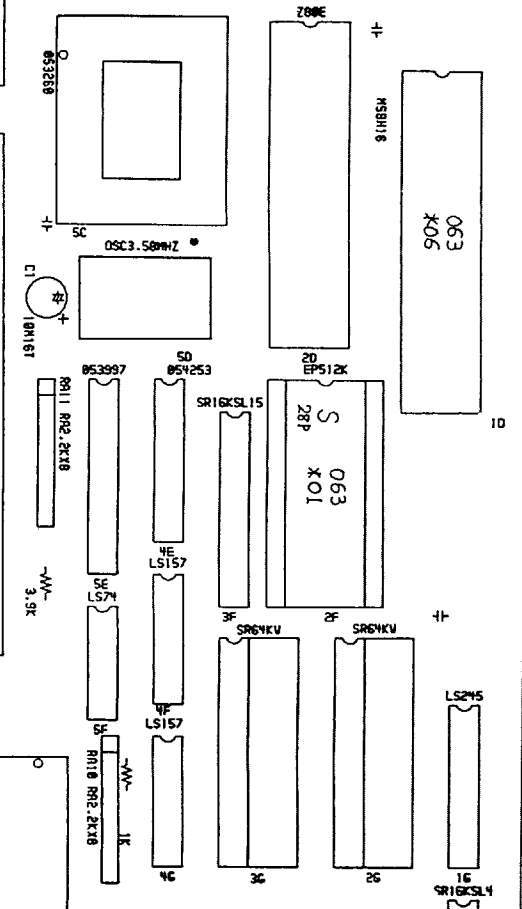
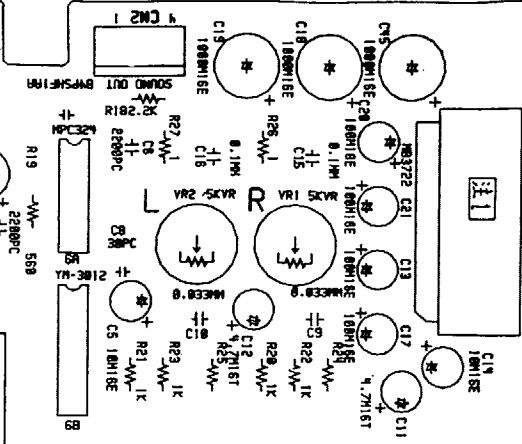

KONAMI PWB352359C

MADE IN JAPAN

CONTROL PANEL DRILLING TEMPLATE

Use this Template for All 4 Players Controls

Player 1 Blue
Player 2 Orange
Player 3 Purple
Player 4 Red



JOYSTICK

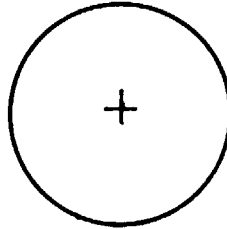

JUMP

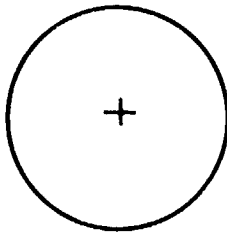

ATTACK

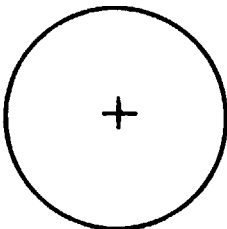

WIRING DIAGRAM

GX063
PWB 352359C

NOTICE TO ALL PERSONS RECEIVING THIS DRAWING
 PROPRIETARY AND CONFIDENTIAL. Reproduction, forbidden, without the specific written permission of Konami Co., Ltd., 7-3-2 Minatogamine-Hakomachi, Chou-ku, Kobe 650, Japan. This drawing is only conditionally issued. Neither receipt nor possession of this drawing or any operating manual relating to Konami's games or products containing this drawing conveys or transfers any right in or license to use the printed circuit boards relating to this drawing or other subject matter of the drawing or any design or technical information shown thereon. Except for manufacture by vendors of Konami Co., Ltd. and for manufacture under Konami's written license, no right is granted to reproduce, make, have made, use or sell this drawing or the subject matter thereof including, without limitation, the printed circuit board or operating manual relating thereto, whatsoever, unless by written agreement with or written permission from Konami. Copyright 1991 Konami Co., Ltd. All rights reserved.

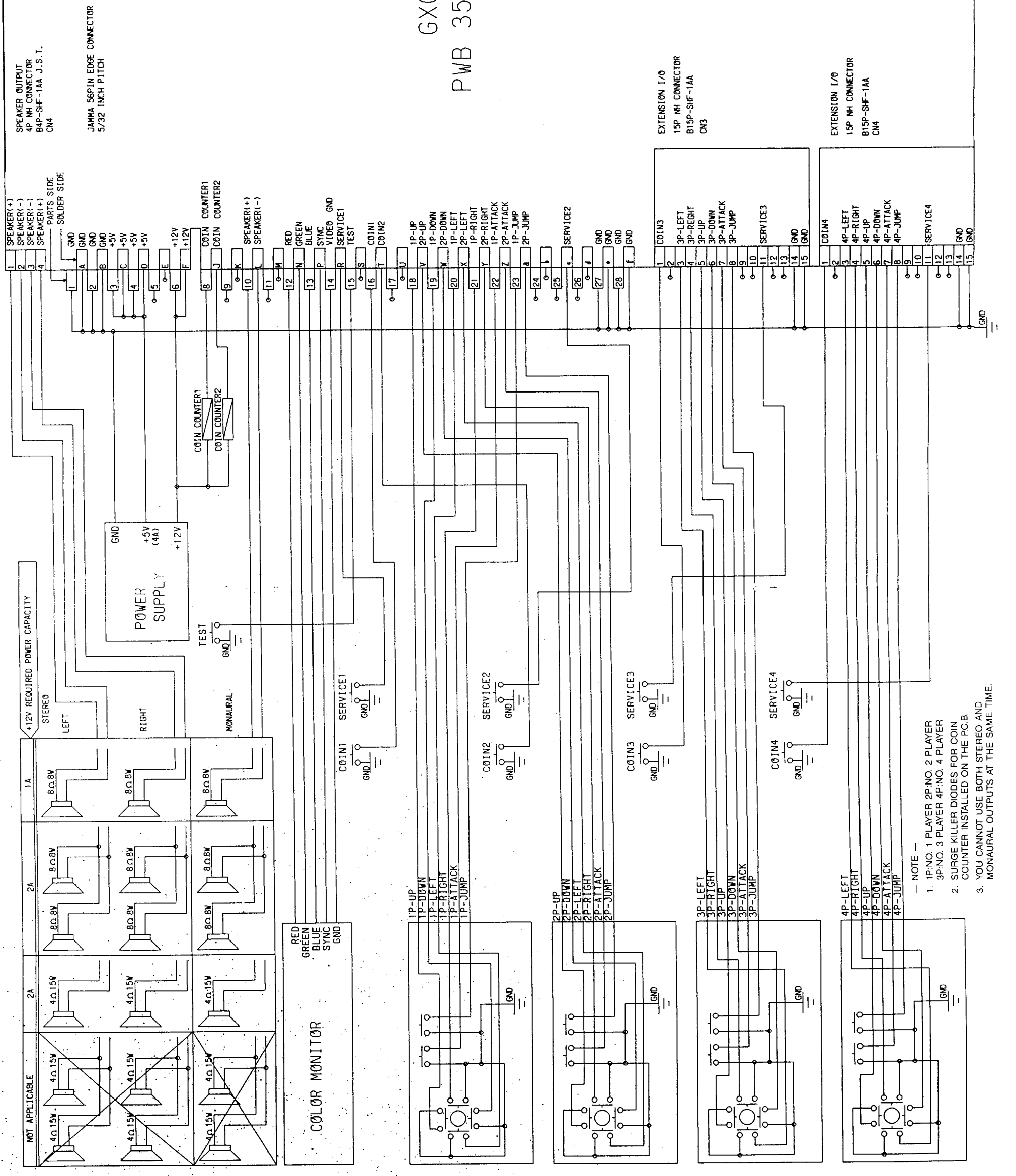

CONTROL FOR 1P

CONTROL FOR 2P

CONTROL FOR 3P

CONTROL FOR 4P

- NOTE —
- 1P:NO. 1 PLAYER 2P:NO. 2 PLAYER
3P:NO. 3 PLAYER 4P:NO. 4 PLAYER
 - SURGE KILLER DIODES FOR COIN COUNTER INSTALLED ON THE P.C.B.
 - YOU CANNOT USE BOTH STEREO AND MONAURAL OUTPUTS AT THE SAME TIME.

SPEAKER OUTPUT
4P NH CONNECTOR
B4P-SHF-1AA J.S.I.
CN4

JAMMA 56PIN EDGE CONNECTOR
5/32 INCH PITCH

EXTENSION I/O
15P NH CONNECTOR
B15P-SHF-1AA
CN3

EXTENSION I/O
15P NH CONNECTOR
B15P-SHF-1AA
CN4

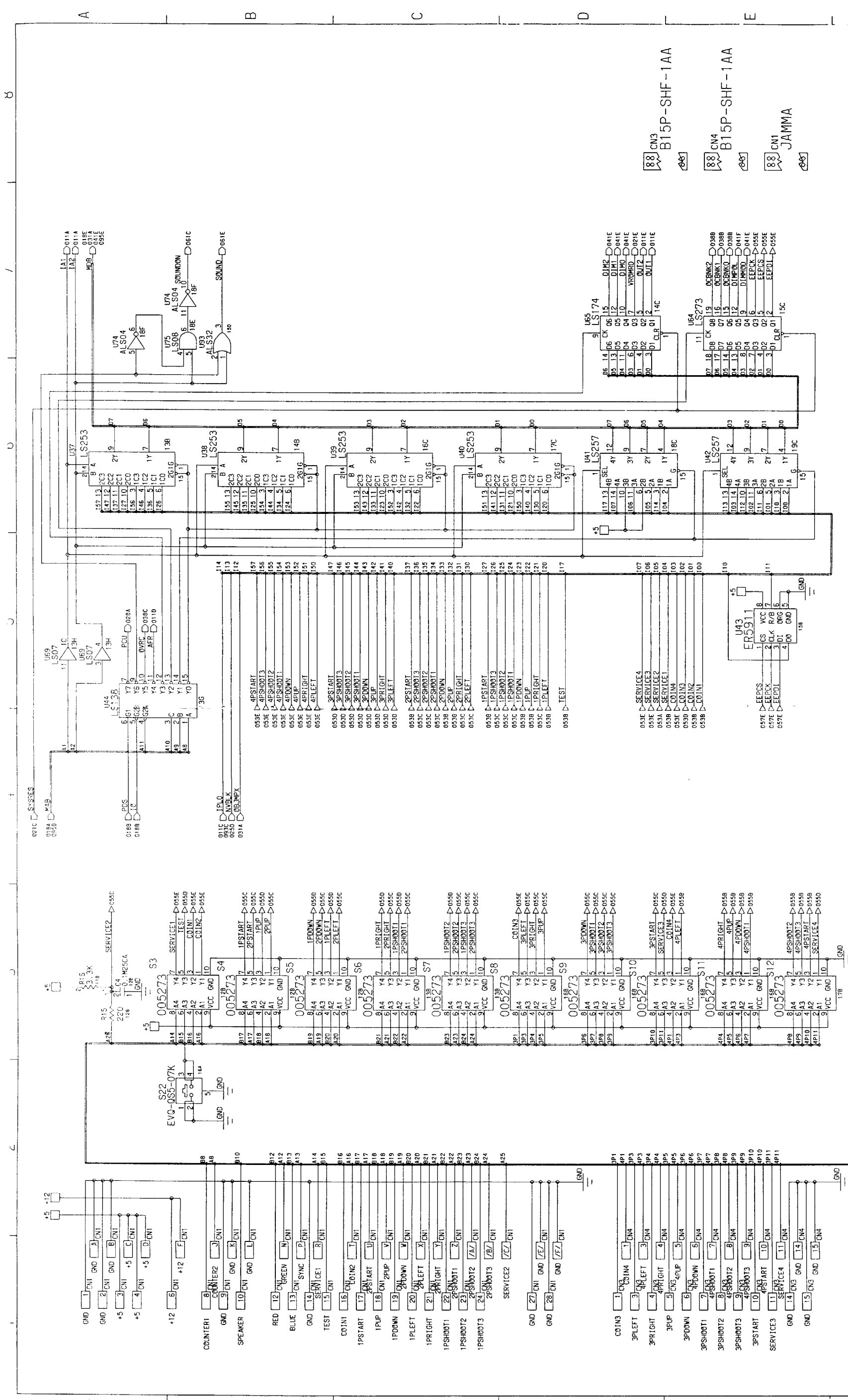

DRAWING		DESIGN		TITLE		SCHEMATIC	
KONAMI		K. FURUKAWA		K. FURUKAWA		05	
KONAMI CO., LTD.		CHECK		SUBTITLE		PAGE	
		APPROVE		CODE NO.		352995	
		SCALE		REG. TYPE		GX063	
		TOLERANCE		SECURITY LEVEL		CONFIDENTIAL	
		DATE		1991/09/18		7	

PROPRIETARY AND CONFIDENTIAL: THE SPECIFIC WRITTEN PERMISSION OF KONAMI CO., LTD. 7-3-2, MINATOJIMA-MAKEMACH, CHUO-KU, KOBÉ 650, JAPAN. THIS DRAWING IS ONLY CONDITIONALLY ISSUED. NEITHER REPRODUCTION NOR POSSESSION OF THIS DRAWING OR ANY OPERATING MANUAL RELATING TO KONAMI'S GAMES OR PRODUCTS CONTAINING THIS DRAWING CONFERS OR TRANSFERS ANY RIGHT IN OR LICENSE TO USE THE PRINTED CIRCUIT BOARDS RELATING TO THIS DRAWING OR OTHER SUBJECT MATTER OF THIS DRAWING OR ANY DESIGN OR TECHNICAL INFORMATION SHOWN THEREON, EXCEPT FOR MANUFACTURE BY VENDORS OF KONAMI CO., LTD. AND FOR MANUFACTURE UNDER KONAMI'S WRITTEN LICENSE. NO RIGHT IS GRANTED TO REPRODUCE, MAKE, HAVE MADE, USE OR SELL THIS DRAWING OR THE SUBJECT MATTER THEREOF INCLUDING, WITHOUT LIMITATION, THE PRINTED CIRCUIT BOARD OR OPERATING MANUAL RELATING HERETO, WHATSOEVER, UNLESS BY WRITTEN PERMISSION WITH OR WRITTEN PERMISSION FROM KONAMI. COPYRIGHT 1991 KONAMI CO., LTD. ALL RIGHTS RESERVED.

014E	CNT1	1
014E	CNT2	2
066E	LEFT	3
048E	RED	4
048E	GREEN	5
048E	BLUE	6
048E	SYNC	7

A B C D E F

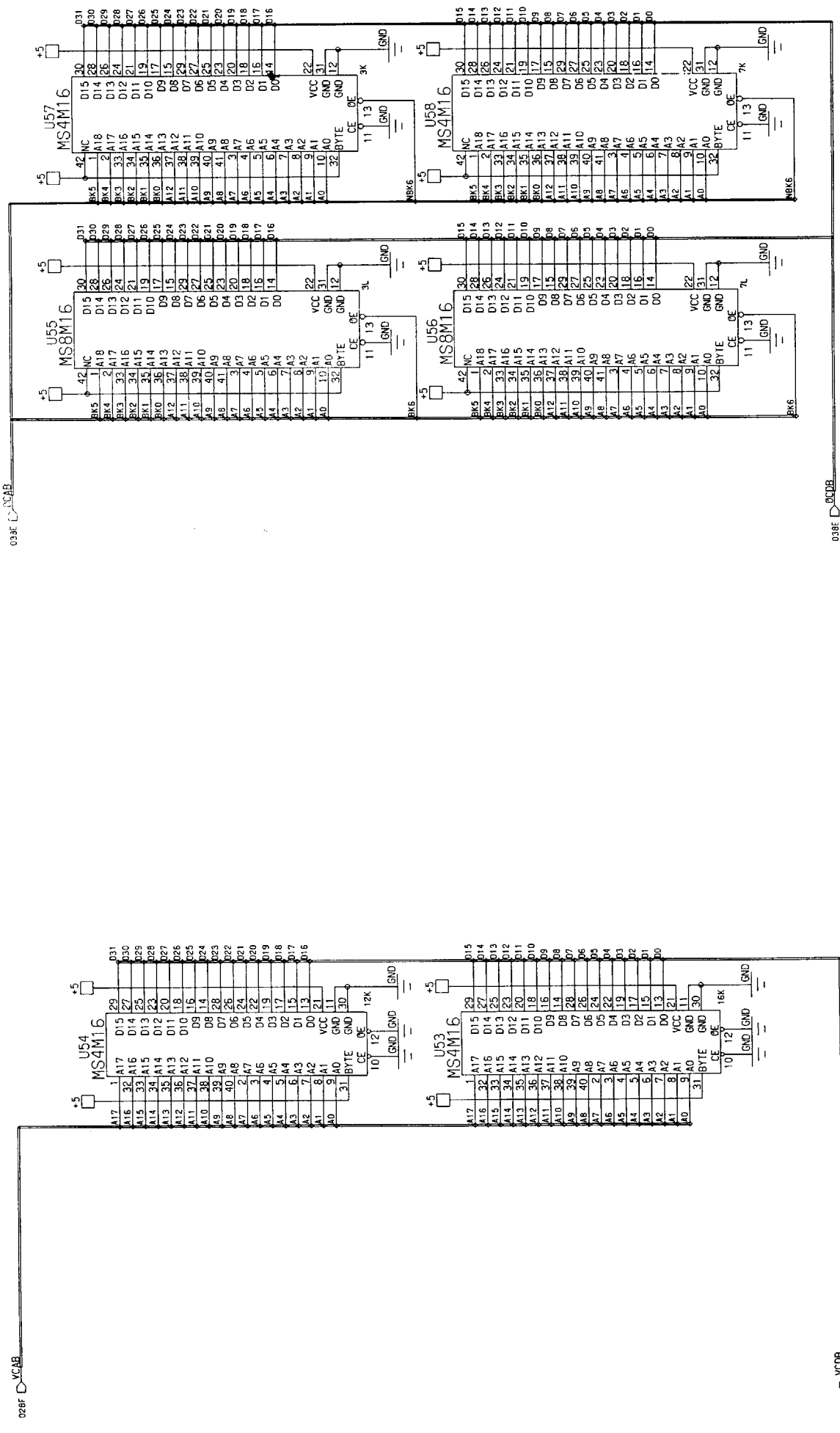

028E DVCDB

028E DVCDB

PROPRIETARY AND CONFIDENTIAL:
 REPRODUCTION FORBIDDEN WITHOUT THE SPECIFIC WRITTEN PERMISSION OF KONAMI CO., LTD. 7-3-2.
 HINOKIJIWA-NAKAMACHI, COGEE JAPAN. THIS DRAWING IS ONLY CONDITIONALLY ISSUED. NEITHER
 RECEIPT NOR POSSESSION OF THIS DRAWING OR ANY OPERATING MANUAL RELATING TO KONAMI'S GAMES OR PRODUCTS
 ENTITLES TO THIS DRAWING OR OTHER SUBJECT MATTER OF THE DRAWING OR ANY LICENSE TO USE THE PRINTED CIRCUIT BOARDS
 SHOWN THEREON. EXCEPT FOR MANUFACTURE BY VENDORS OF KONAMI CO., LTD. AND FOR MANUFACTURE UNDER
 KONAMI'S WRITTEN LICENSE. NO RIGHT IS GRANTED TO REPRODUCE, MAKE, HAVE MADE, USE OR SELL THIS DRAWING
 OR THE SUBJECT MATTER THEREOF, INCLUDING, WITHOUT LIMITATION, THE PRINTED CIRCUIT BOARD OR OPERATING MANUAL
 RELATING THERETO, WHATSOEVER, UNLESS BY WRITTEN AGREEMENT WITH OR WRITTEN PERMISSION FROM KONAMI.
 COPYRIGHT 1991, KONAMI CO., LTD. ALL RIGHTS RESERVED.



DESIGN	TITLE	SCHEMATIC
DRAW	SUBTITLE	07
CHECK	PAGE	
APPROVE	CODE NO.	352995
SCALE	REG. TYPE	GX063
TOLERANCE	SECURITY LEVEL	CONFIDENTIAL
DATE		

DRAWING

K. FURUKAWA
 K. FURUKAWA
 K. Furukawa
 K. Furukawa
 1991/09/18

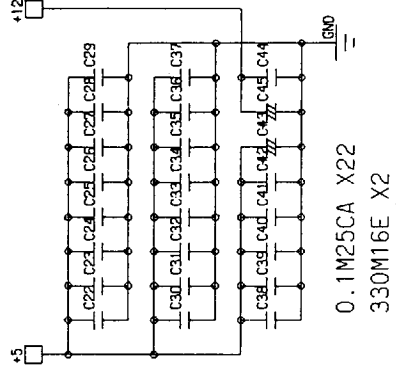
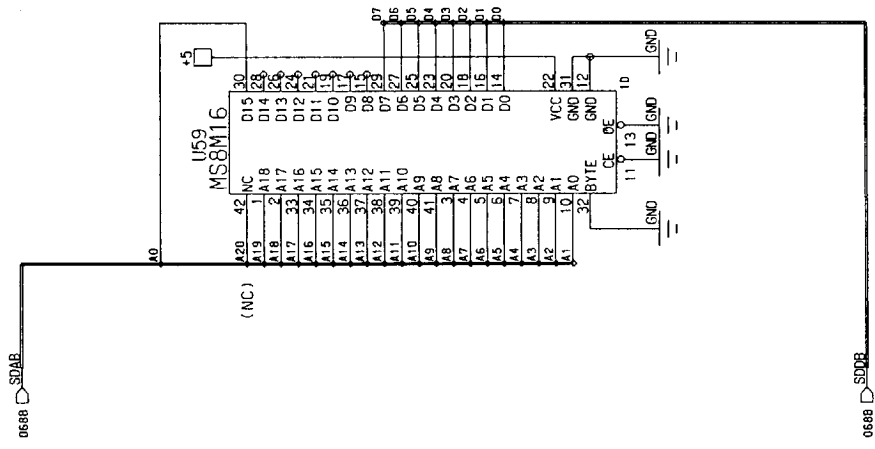

0.1M25CA X22
330M16E X2

PROPRIETARY AND CONFIDENTIAL:
REPRODUCTION FORBIDDEN WITHOUT THE SPECIFIC WRITTEN PERMISSION OF KONAMI CO., LTD. 7-3-2, MINATOJIMA-NAKAMACHI, CHUO-KU, KOBE 650, JAPAN. THIS DRAWING IS ONLY CONDITIONALLY ISSUED. NEITHER RECEIPT NOR POSSESSION OF THIS DRAWING OR ANY OPERATING MANUAL RELATING TO THE DRAWING OR ANY PRINTED CIRCUIT BOARDS CONTAINING THIS DRAWING CONFERS OR TRANSFERS ANY RIGHT OR INTEREST IN THE DRAWING OR ANY DESIGN OR TECHNICAL INFORMATION RELATING TO THIS DRAWING OR MANUFACTURE BY VENDORS OF KONAMI CO., LTD. AND FOR MANUFACTURE UNDER SHOWN LICENSE. EXCEPT AS SHOWN, NO RIGHT IS GRANTED TO REPRODUCE, MAKE, HAVE MADE, USE OR SELL THIS DRAWING OR THE SUBJECT MATTER THEREOF, INCLUDING, WITHOUT LIMITATION, THE PRINTED CIRCUIT BOARD OR OPERATING MANUAL RELATING THERETO, WHATSOEVER, UNLESS BY WRITTEN AGREEMENT WITH OR WRITTEN PERMISSION FROM KONAMI. COPYRIGHT 1991 KONAMI CO., LTD. ALL RIGHTS RESERVED.



KONAMI CO., LTD.

DESIGN	K. FURUKAWA	TITLE	SCHMATIC
DRAM	K. FURUKAWA	SUBTITLE	08
CHECK	<i>Y. Iijima</i>	PAGE	
APPROVE	<i>K. Iijima</i>	CODE NO.	352995
SCALE		REG. TYPE	GX063
TOLERANCE		SECURITY LEVEL	CONFIDENTIAL
DATE	1991/09/18		

THIS EQUIPMENT COMPLIES WITH THE REQUIREMENTS IN PART 15 OF FCC RULES FOR A CLASS A COMPUTING DEVICE. OPERATION OF THIS EQUIPMENT IN A RESIDENTIAL AREA MAY CAUSE UNACCEPTABLE INTERFERENCE TO RADIO AND TV RECEPTION REQUIRING THE OPERATOR TO TAKE WHATEVER STEPS ARE NECESSARY TO CORRECT THE INTERFERENCE. THIS DEVICE MUST ACCEPT ANY INTERFERENCE RECEIVED, INCLUDING INTERFERENCE THAT MAY CAUSE UNDESIREED OPERATION.



KONAMI®

900 Deerfield Parkway, Buffalo Grove, 60089-4510
Telephone: (708) 215-5100, Telex: 6871385 KONAM UW, Fax: (708) 215-5122