



SUNSETRIDERS

© KONAMI 1991 TM

Service #

708-215-5100

Jerry Korbecki ext. 122

INSTRUCTION MANUAL



 **KONAMI**® is a trademark of Konami Industry Co., Ltd.

Sunsetriders is a registered trademark of Konami Co. LTD. © 1991 Konami Co. Inc.

SUNSETRIDERS™ PARTS LIST

Part #	Description
072010	AC Harness
064011	DC Harness
064003	Sunsetrider PCB
064100	Sunsetrider Control Panel Overlay
064101	Instruction Decal (w/arrows)
064200	Marquee
064300	Upper Right Side Decal
064301	Upper Left Side Decal
064302	Middle Right Side Decal
064303	Middle Left Side Decal
064304	Lower Right Side Decal
064305	Lower Left Side Decal
064400	Manual
30255	Red Button
30256	Yellow Button
30258	Blue Button
30259	Green Button
30313	Red Micro Joystick
30314	Blue Micro Joystick
30315	Green Micro Joystick
30316	Yellow Micro Joystick
35404	Power Supply
40356	Tempered Glass
40524	Monitor

CONTROL PANEL ASSEMBLY

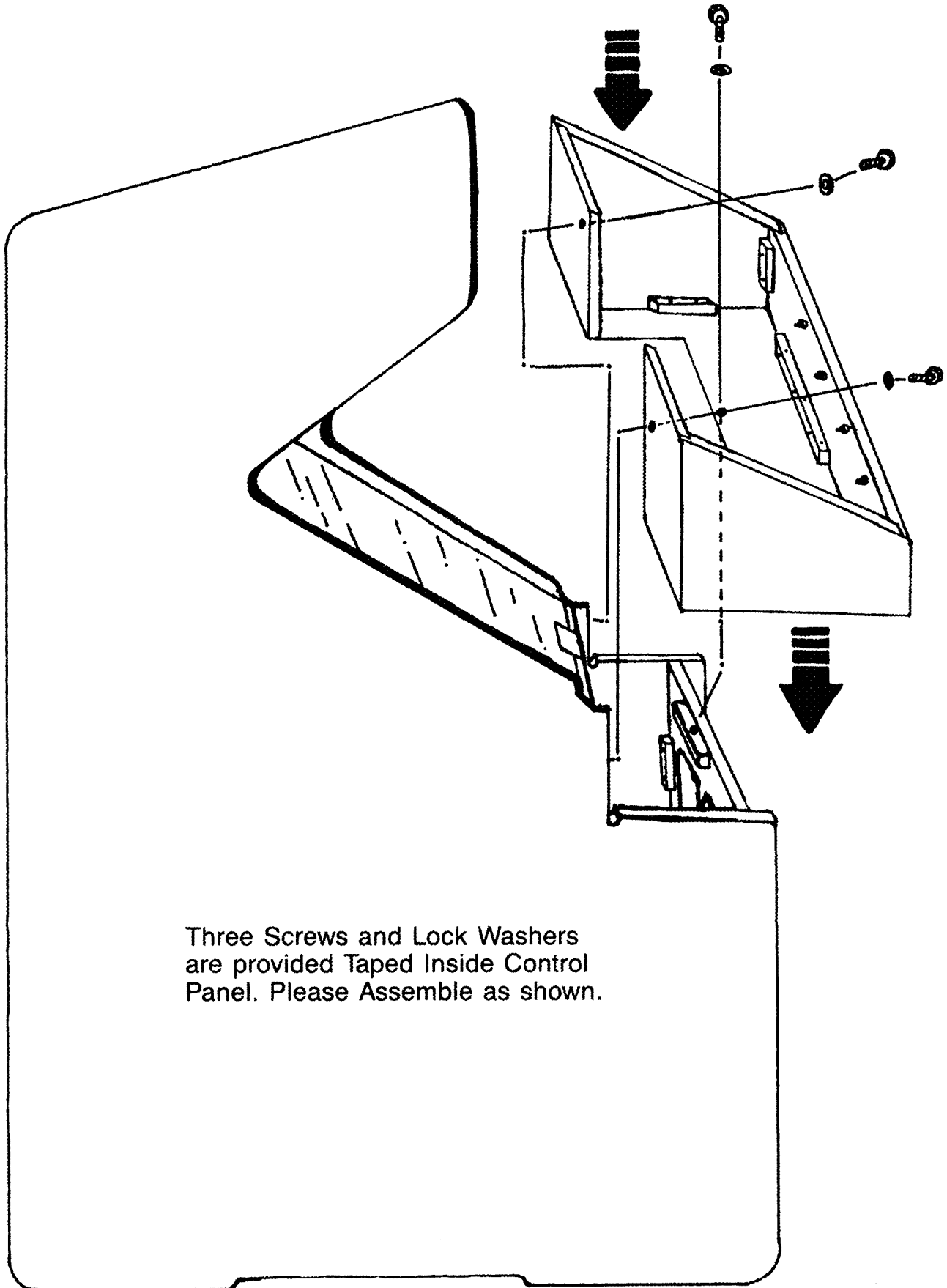

Three Screws and Lock Washers
are provided Taped Inside Control
Panel. Please Assemble as shown.

SUNSETRIDERS™ TECHNICAL INFORMATION

TECHNICAL INFORMATION

- (1) Required power capacity
GND-Vcc 5V 4A or more
GND-(+12V)
*See the Wiring Diagram.
- (2) Output
R (red) analog, positive
G (green) analog, positive
B (blue) analog, positive
SYNC. H-V complexed, negative
- (3) The monitor should be horizontally installed.
- (4) Use the volume knob on the PCB to adjust sound level.
Turn the knob clockwise for increased volume. In monaural output mode, use the left volume knob.
- (5) Handle with care.

PLAY INSTRUCTION

- 1 to 4 players can play at the same time.
- Decide the character you want to control out of the four Bounty Hunters. Two of them use pistols as their weapons, the others use rifles. Deposit coin(s) in coin slot of your favorite character and press SHOOT or JUMP button to start the game.
- Control your character using the 8-way JOYSTICK. Use JUMP button to get over obstacles. Press SHOOT button to attack enemies. Enemies can also be destroyed by shooting down barrels and lamps aimed at them.
- To jump up to the second floor, push JOYSTICK upward and press JUMP button. To jump down, pull down JOYSTICK and press JUMP button.
- To avoid enemies' bullets, you can slide by pressing JUMP button with JOYSTICK pulled diagonally downward.
- Shoot sacks, and gold and silver badges come out. Pick them up for power-up:
Gold badge: QUICK DRAW. . . Keep SHOOT button pressed to fire consecutively.
Silver badge: TWO-GUNS. . . You can fire in two directions.
- Pick up gold dust and roast-chickens for additional points. Extra points are also awarded for picking up the same power-up item you already have.
- You will lose a life when you are hit by enemies' bullets, runaway bulls, falling barrels and flames, etc. The game is over when you have lost all your lives.
- There are eight stages and two bonus stages. A large reward is given you for defeating the boss enemy in each stage. In bonus stages, aim and shoot the enemies coming out in eight different positions. Shoot as many enemies as possible for maximum reward.
- Continuation is available as long as you continue to add coins when necessary. Any player can join at anytime.

CABINET INFORMATION

- (1) Use a multi-control upright cabinet with four sets of an 8-way joystick and two function buttons.
- (2) Four independent coin slots are necessary. Start buttons are substituted by the function buttons for each player.

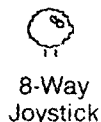

SUNSETRIDERS™ TECHNICAL INFORMATION (cont.)

SELF TEST

Normal: "OK" will be displayed. Then the game will start.

Abnormal: "BAD" will be displayed and self test will repeat. If "EEPROM 15B BAD" is displayed, switch off and switch on again with TEST SWITCH (on the PCB) pressed.

MANUAL TEST

(1) HOW TO START

After switching on the power, press the TEST SWITCH on the PCB or on the cabinet, and you will get the MAIN MENU of the Manual Test.

NOTE: Switching on with TEST SWITCH pressed causes the program in the EEPROM to be initialized to default.

(2) HOW TO RETURN TO THE GAME MODE

Select "GAME MODE" on the MAIN MENU, then press 1 SHOOT button to return to the game mode.

(3) ITEMS AND HOW TO SELECT

Use player 1 JOYSTICK to highlight desired test and press player 1 SHOOT button to initiate testing. Press player 1 SHOOT button during or at the end of each test to return to the MAIN MENU.

I/O CHECK SCREEN CHECK COLOR CHECK SOUND CHECK MASK ROM CHECK GAME OPTIONS COIN OPTIONS GAME MODE 1 PLAYER JOYSTICK = SELECT ITEM 1 PLAYER SHOOT = DO CHECK
--

(4) EXPLANATION OF THE ITEMS

1. I/O CHECK

Check all the joysticks and buttons to see "1" when switched on. Press player 1 and 2 SHOOT buttons at the same time to return to MAIN MENU.

2. SCREEN CHECK

Adjust focus, alignment, size, etc. using the cross-hatch screen.

3. COLOR CHECK

Adjust color brightness so that the specified area will be colorless.

4. SOUND CHECK

When "SOUND SCALE CHECK" is highlighted, a music scale sounds. At "SOUND CODE," push player 1 JOYSTICK right/left to change sound code.

5. MASK ROM CHECK

Roms will be checked one after another, and the message "OK" or "BAD" will be displayed on the screen.

SUNSETRIDERS™ TECHNICAL INFORMATION (cont.)

6. GAME OPTIONS

Following screen will appear. Use player 1 JOYSTICK up/down to select the item and push JOYSTICK right/left to modify setting. Factory settings are shown in green, and modified results in red.

After modification is completed, highlight "SAVE AND EXIT" and press player 1 SHOOT button to save and return to MAIN MENU.

GAME OPTIONS	
PLAYER'S LIFE	1 CREDIT 3 LIVES
DIFFICULTY LEVEL	4/MEDIUM
VIDEO SCREEN FLIP	NORMAL
SOUND OUTPUT	STEREO
SOUND IN ATTRACT MODE	ON
FACTORY SETTINGS	
SAVE AND EXIT	
EXIT	
1 PLAYER JOYSTICK UP/DOWN=SELECT OPTION	
1 PLAYER JOYSTICK RIGHT/LEFT=MODIFY SETTING	

- ... Select from 1 to 9 lives.
- ... Select out of 8 levels.
- ... "NORMAL" or "UPSIDE DOWN"
- ... "STEREO" or "MONAURAL"
- ... "ON" or "OFF"
- ... All the settings return to default.
- ... Save the modified settings

* If you select "EXIT" instead of "SAVE AND EXIT" after modifying some settings, the message appears: "YOU DID NOT SAVE. DO YOU WANT TO SAVE? YES/NO." When you choose "YES" the screen shows "NOW SAVING" and returns to MENU SCREEN. If you select "NO," "NO MODIFICATION" is shown and then MENU SCREEN appears.

7. COIN OPTIONS

Selecting this item, the screen shows following options.

COIN OPTIONS	
FREE PLAY	NO
PREMIUM START	YES 1
STARTING	2 COINS 1 CREDIT
CONTINUATION	1 COIN 1 CREDIT
FACTORY SETTINGS	
SAVE AND EXIT	
EXIT	
1 PLAYER JOYSTICK UP/DOWN=SELECT OPTION	
1 PLAYER JOYSTICK RIGHT/LEFT=MODIFY SETTING	

- ... "NO" or "YES 1" to "YES 4"
- (The number means the EXTRA coins necessary)

} Same as above "GAME OPTIONS"

When you want "PREMIUM START" setting, choose the number of extra coins necessary for starting, then decide the coin setting for continuation. The number of coins for starting will be the sum of both numbers. If you do not want premium start setting, the number of coins necessary for starting and continuation will be the same.

*COIN SETTING OPTIONS

COIN (S)	1	1	1	1	1	1	1	2	2	2	3	3	3	4	4	4
CREDIT (S)	1	2	3	4	5	6	7	1	3	5	1	2	4	1	3	5

AC WIRING HARNESS

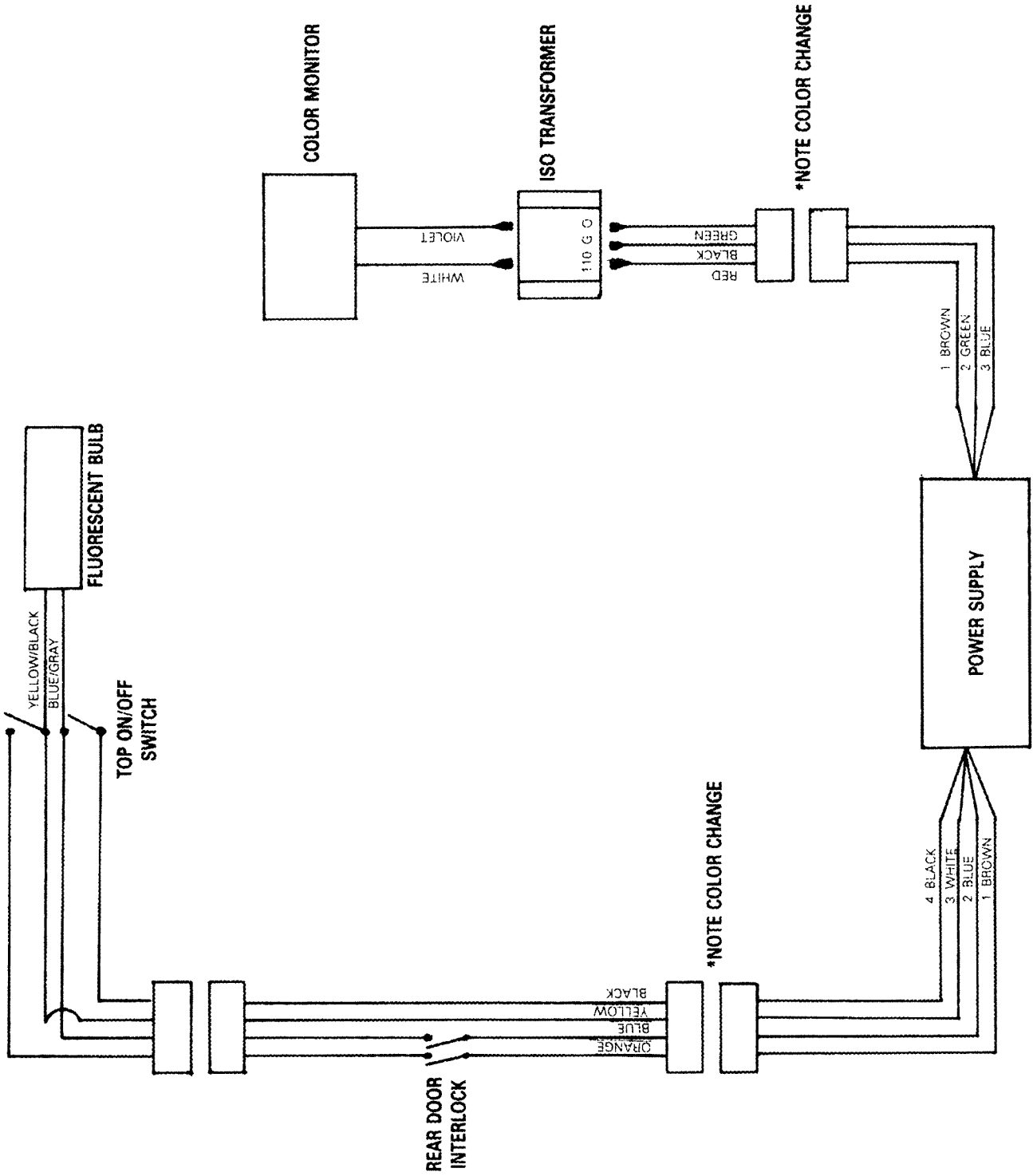

SUNSETRIDER™: SUB HARNESS FOR 3 PLAYERS & 4 PLAYERS

CN3 3P CONTROLS	1	Coin 3	White/Violet
	2	Empty	
	3	3P Left	White/Red
	4	3P Right	White/Yellow
	5	3P Up	White/Black
	6	3P Down	White/Blue
	7	3P Shoot	White/Brown
	8	3P Jump	White/Orange
	9	Empty	
	10	Empty	
	11	Empty	
	12	Empty	
	13	Empty	
	14	Empty	
	15	Ground	Black

CN4 4P CONTROLS	1	Coin 4	Blue
	2	Empty	
	3	4P Left	Yellow/Black
	4	4P Right	Brown/Black
	5	4P Up	Green/Yellow
	6	4P Down	Yellow/Red
	7	4P Shoot	Yellow/White
	8	4P Jump	Yellow/Blue
	9	Empty	
	10	Empty	
	11	Empty	
	12	Empty	
	13	Empty	
	14	Empty	
	15	Ground	Black

SUNSETRIDER™: WIRING HARNESS

WIRE COLOR KEY:		Solder Side ←		→ Parts Side		
BLACK	GND	A	1	GND		BLACK
BLACK	GND	B	2	GND		BLACK
RED	+5V DC	C	3	+5V DC		RED
RED	+5V DC	D	4	+5V DC		RED
	NOT USED	E	5	NOT USED		
ORANGE	+12V DC	F	6	+12V DC		ORANGE
	*KEY	H	7	*KEY		
	(EMPTY)	J	8	COIN COUNTER		GREEN/VIOLET
	(EMPTY)	K	9	(EMPTY)		
	(EMPTY)	L	10	(EMPTY)		
	(EMPTY)	M	11	(EMPTY)		
WHITE/GREEN	VIDEO GREEN	N	12	VIDEO RED		RED/WHITE
WHITE	VIDEO SYNC	P	13	VIDEO BLUE		BLUE/WHITE
	(EMPTY)	R	14	VIDEO GROUND		BLACK
	(EMPTY)	S	15	TEST		YELLOW
VIOLET/WHITE	COIN 2	T	16	COIN 1		BLUE/BROWN
	NOT USED	U	17	(EMPTY)		
BLUE/YELLOW	2P UP	V	18	1P UP		ORANGE/WHITE
VIOLET/YELLOW	2P DOWN	W	19	1P DOWN		BLACK/WHITE
ORANGE/GREEN	2P LEFT	X	20	1P LEFT		RED/GRAY
ORANGE/YELLOW	2P RIGHT	Y	21	1P RIGHT		GRAY/WHITE
BLACK/YELLOW	2P SHOOT	Z	22	1P SHOOT		RED/WHITE
ORANGE/GRAY	2P JUMP	a	23	1P JUMP		GREEN/BROWN
	NOT USED	b	24	NOT USED		
	NOT USED	c	25	NOT USED		
	NOT USED	d	26	NOT USED		
BLACK	GND	e	27	GND		BLACK
BLACK	GND	f	28	GND		BLACK

(BASE COLOR/LINE COLOR)

THIS EQUIPMENT COMPLIES WITH THE REQUIREMENTS IN PART 15 OF FCC RULES FOR A CLASS A COMPUTING DEVICE. OPERATION OF THIS EQUIPMENT IN A RESIDENTIAL AREA MAY CAUSE UNACCEPTABLE INTERFERENCE TO RADIO AND TV RECEPTION REQUIRING THE OPERATOR TO TAKE WHATEVER STEPS ARE NECESSARY TO CORRECT THE INTERFERENCE. THIS DEVICE MUST ACCEPT ANY INTERFERENCE RECEIVED, INCLUDING INTERFERENCE THAT MAY CAUSE UNDESIRE OPERATION.



900 Deerfield Parkway, Buffalo Grove, 60089-4510
Telephone: (708) 215-5100, Telex: 6871385 KONAM UW, Fax: (708) 215-5122

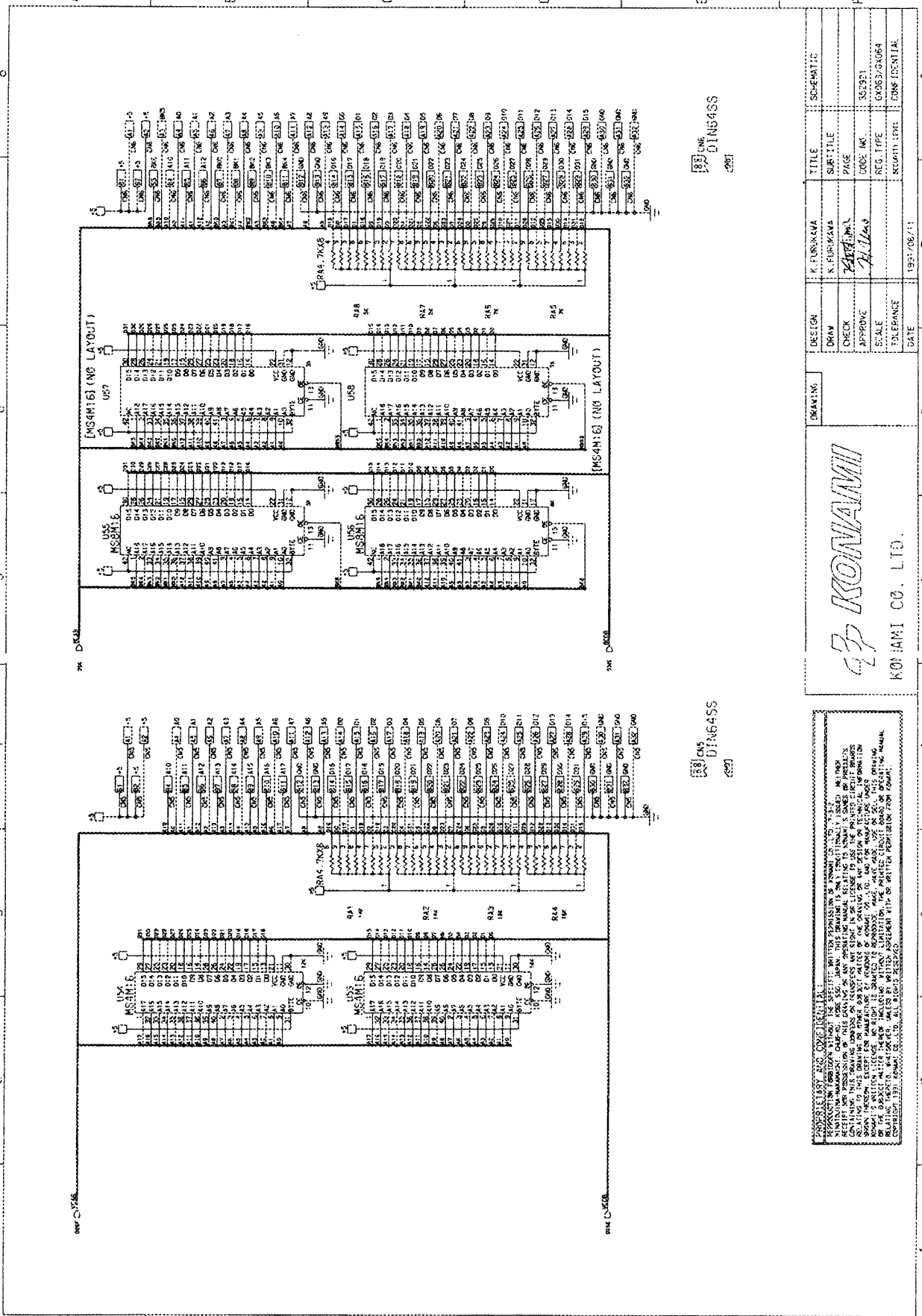

881045
DIN6455
0991

881045
DIN6455
0991

DESIGN	DESIGNER	TITLE	SCHEMATIC
DRW	K. FURUKAWA	SURTITLE	
CHECK	K. FURUKAWA	PAGE	
APPROVE	H. Ueda	DOCS. NO.	305971
SCALE		REG. TYPE	COB33/G004
TOLERANCE		SECURITY INFO.	CONFIDENTIAL
DATE	1997/02/11		

KONAMI
KONAMI CO., LTD.

PROCESSED BY AND CONFIDENTIAL
 REPRODUCTION OR TRANSMISSION WITHOUT THE SPECIFIC WRITTEN PERMISSION IS PROHIBITED IN ALL COUNTRIES.
 THIS DOCUMENT IS THE PROPERTY OF KONAMI AND IS LOANED TO YOU. IT IS TO BE USED ONLY FOR THE PURPOSES SPECIFIED.
 CONTAINING TRADE MARKS OR PATENT RIGHTS OF KONAMI OR OTHER COMPANIES. THE USER SHALL BE RESPONSIBLE FOR OBTAINING NECESSARY PERMISSIONS FROM THE APPLICABLE PATENT OFFICES.
 KONAMI CORPORATION, 3-1-1, SHIBUYA-SCIENCE CITY, SHIBUYA-KU, TOKYO 151, JAPAN.

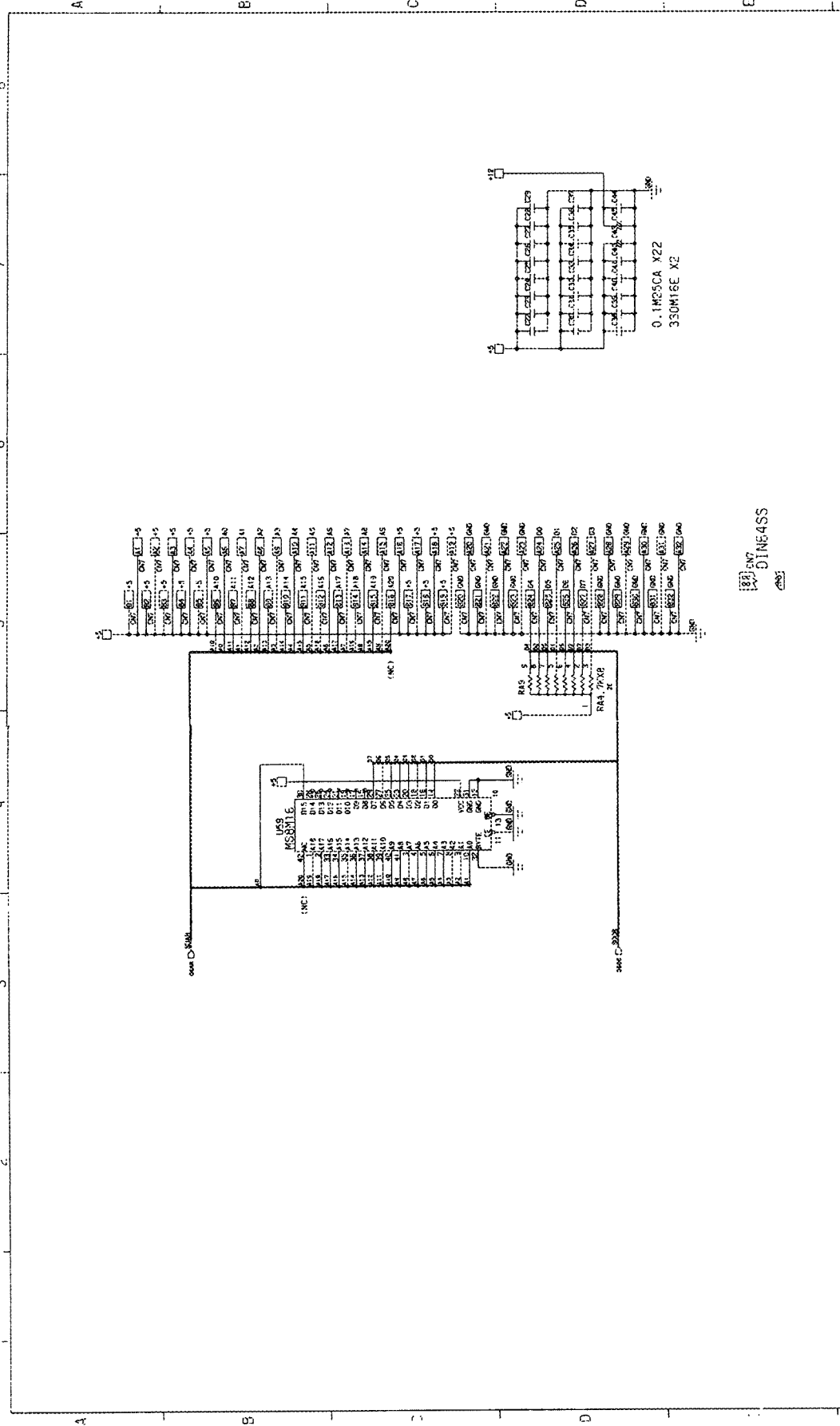

0.1MS5CA X22
330M16E X2

DESIGN	TITLE	SOLEMATIC
DRWN	K. FURUKAWA	
CHECK	K. FURUKAWA	
APPROVE	M. SHIMIZU	
SCALE	1:1	
TOLERANCE		
DATE	1991/06/11	

DRAWING



KONAMI
KONAMI CO., LTD.

PROPRIETARY AND CONFIDENTIAL

PERMISSION TO REPRODUCE THIS DOCUMENT IS GRANTED BY KONAMI CO., LTD. TO THE USER FOR PERSONAL USE ONLY. NO PART OF THIS DOCUMENT OR THE CONTENTS HEREIN MAY BE REPRODUCED OR TRANSMITED IN ANY FORM OR BY ANY MEANS, ELECTRONIC OR MECHANICAL, INCLUDING PHOTOCOPYING, RECORDING, OR BY ANY INFORMATION STORAGE AND RETRIEVAL SYSTEM, WITHOUT PERMISSION IN WRITING FROM KONAMI CO., LTD. ALL RIGHTS RESERVED.

DESIGN	TITLE	SOLEMATIC
DRWN	K. FURUKAWA	
CHECK	K. FURUKAWA	
APPROVE	M. SHIMIZU	
SCALE	1:1	
TOLERANCE		
DATE	1991/06/11	

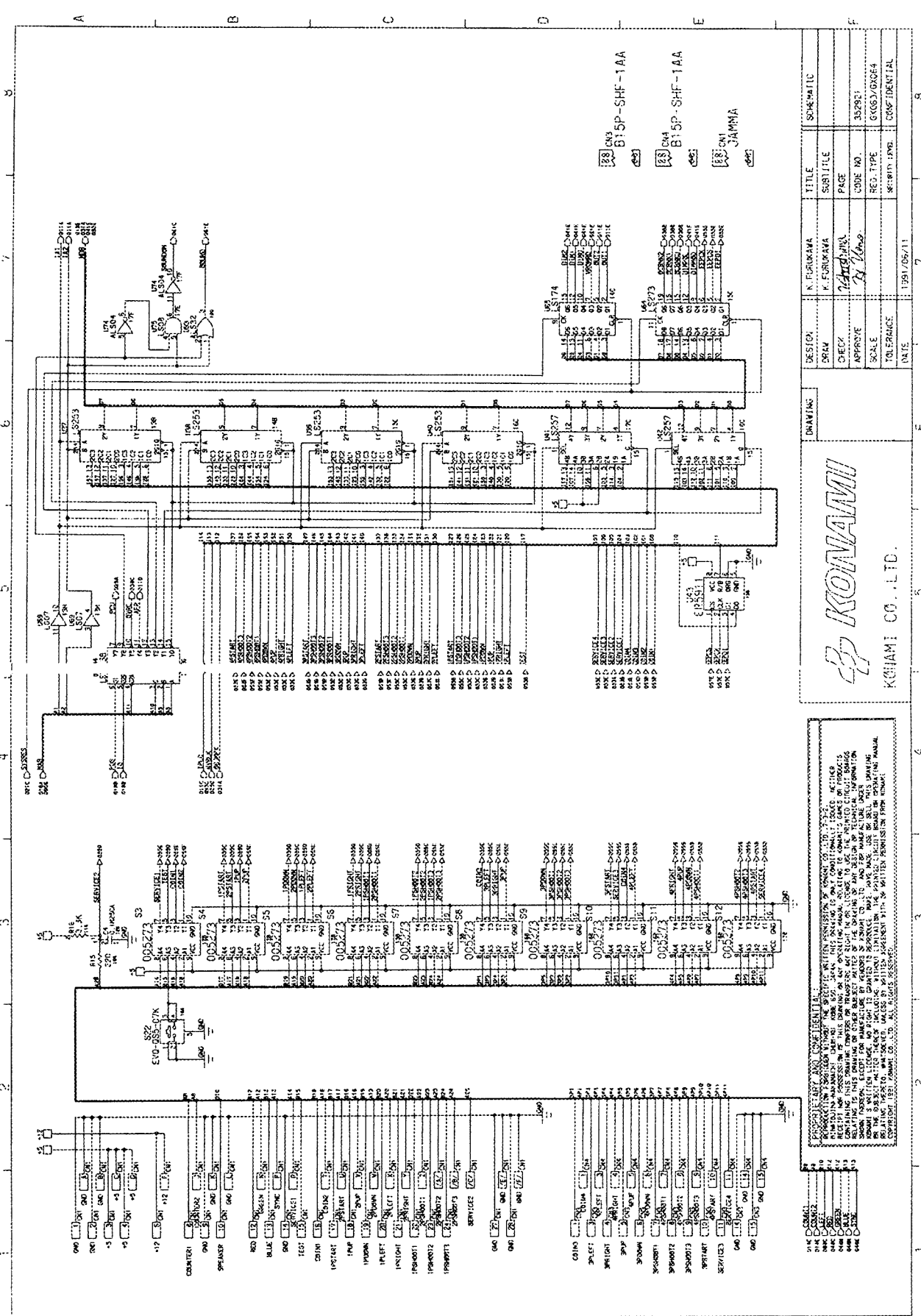

B: 5P-SHF-1AA
 B: 5P-SHF-1AA
 B: 5P-SHF-1AA
 B: 5P-SHF-1AA
 B: 5P-SHF-1AA

TITLE	SUBTITLE	PAGE	CODE NO.	REV. TYPE	SECURITY INFO.
K. FURUKAWA	K. FURUKAWA	35/2951	35/2951	CONFIDENTIAL	
CHECK					
APPROVE					
SCALE					
TOLERANCE					
DATE					

KONAMI

KONAMI CO., LTD.

PRODUCE, PART AND CONFIDENTIAL.
 INFORMATION IS UNCLASSIFIED UNLESS THE SERVICE WRITTEN PERMISSION IS OBTAINED FROM THE
 DIRECTOR OF THE NATIONAL ARCHIVES AND RECORDS ADMINISTRATION. FOR MORE INFORMATION, CONTACT THE
 NATIONAL ARCHIVES AND RECORDS ADMINISTRATION, COLLEGE PARK, MARYLAND 20740. (301) 837-1100
 CONTAINING THIS INFORMATION IS UNCLASSIFIED UNLESS THE SERVICE WRITTEN PERMISSION IS OBTAINED FROM THE
 DIRECTOR OF THE NATIONAL ARCHIVES AND RECORDS ADMINISTRATION. FOR MORE INFORMATION, CONTACT THE
 NATIONAL ARCHIVES AND RECORDS ADMINISTRATION, COLLEGE PARK, MARYLAND 20740. (301) 837-1100
 THIS INFORMATION IS UNCLASSIFIED UNLESS THE SERVICE WRITTEN PERMISSION IS OBTAINED FROM THE
 DIRECTOR OF THE NATIONAL ARCHIVES AND RECORDS ADMINISTRATION. FOR MORE INFORMATION, CONTACT THE
 NATIONAL ARCHIVES AND RECORDS ADMINISTRATION, COLLEGE PARK, MARYLAND 20740. (301) 837-1100

NO.	DATE	BY	REVISION
1			
2			
3			
4			
5			

WIRING DIAGRAM

GX064
PWB 352359B

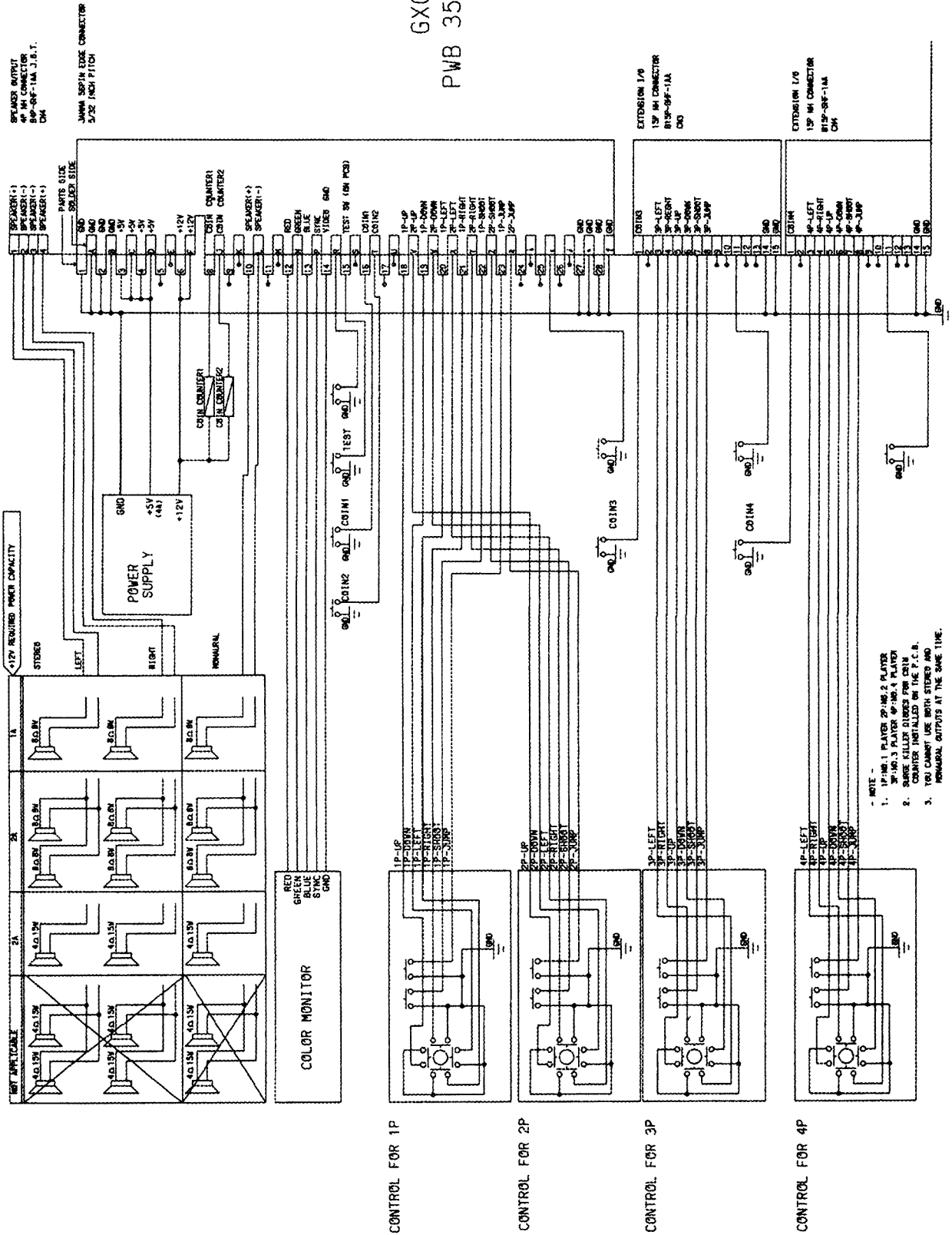

SPEAKER OUTPUT
4P 1H CONNECTOR
81P-8P-1A
OM

JAWNA 50P IN EDGE CONNECTOR
5/32 INCH PITCH

EXTENSION I/O
13P 1H CONNECTOR
81P-8P-1A
OM

EXTENSION I/O
13P 1H CONNECTOR
81P-8P-1A
OM

CONTROL FOR 1P

CONTROL FOR 2P

CONTROL FOR 3P

CONTROL FOR 4P