

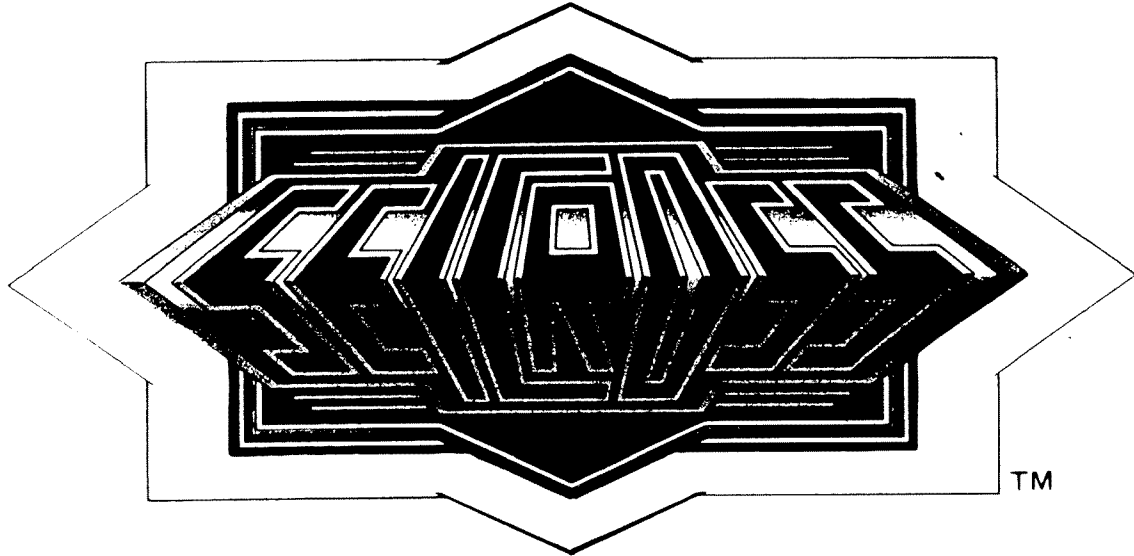



INSTRUCTION MANUAL





Nichibutsu

Nichibutsu

HOW TO PLAY

- The 8-Way Joystick controls 'GILGIT' 
- Destroy Enemy Bikes by Bumping them or Shooting with Energy Beam.
- Avoid contact with the 'Ancient Remains'  - They are indestructible
- The Player's Bike will stop when Energy Supply runs out
Keep Refueling by Clearing 'Fuel Marks'  before the Fuel Supply runs out.
- Rescuing 'Petrimen'  will increase your Bonus points.
Don't miss them when they appear on the Screen from time to time.

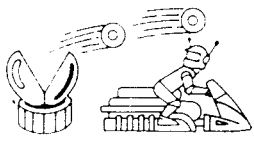
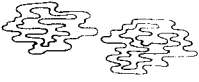
WINNING STRATEGY

1. Bump and Destroy Enemy Bikes. 
2. All the Forts must be destroyed with Energy Beam Gun. Otherwise, there will be a surprise attack from Behind. 
3. Slip-Zone be cautious!! A sudden big move will cause your Bike to Slip. 
4. A Bonus of 8000 points will be awarded when you pick up Eight(8) Petra People in succession.
5.   Forts will not be detonated when they are hit. Avoid contact with the Debris.

"SEICROSS" DIP SWITCH ADJUSTMENTS

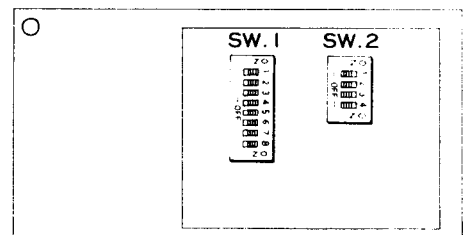

SWITCH 1

OPTION	1	2	3	4	5	6	7	8
3 Bikes	OFF	OFF						
4 Bike	OFF	ON						
2 Bikes	ON	OFF						
5 Bikes	ON	ON						
Easy			OFF					
Hard			ON					
Table				OFF				
Up Right				ON				
20000 & 40000					OFF	OFF		
30000					OFF	ON		
30000 & 50000					ON	OFF		
30000, 60000 & 90000					ON	ON		
Normal							OFF	
Free Play							ON	

SWITCH 2

OPTION	1	2	3	4
Coin 1	1 Coin / 1 Play	OFF	OFF	
	1 Coin / 2 Plays	OFF	ON	
	1 Coin / 3 Plays	ON	OFF	
	1 Coin / 6 Plays	ON	ON	
Coin 2	1 Coin / 1 Play			OFF
	2 Coins / 1 Play			OFF
	3 Coins / 1 Play			ON
	4 Coins / 1 Play			ON

7 THE SCREEN DISPLAY UPSIDE-DOWN OR BACKWARDS

Four wires are attached to the monitor deflection yoke.

Two for the horizontal control, and other two for the vertical control. When the picture is upside down, disconnect the two horizontal wires and swap the connection.

When the picture is backwards, disconnect the two vertical wires and swap the connection.

See figure 5a and 5b.

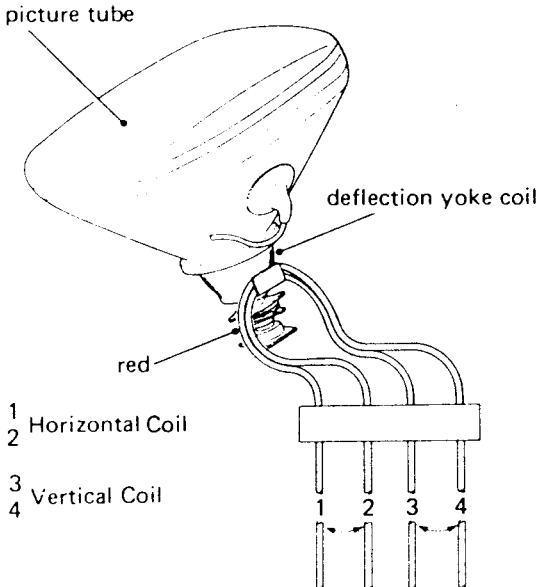

FIGURE 5a

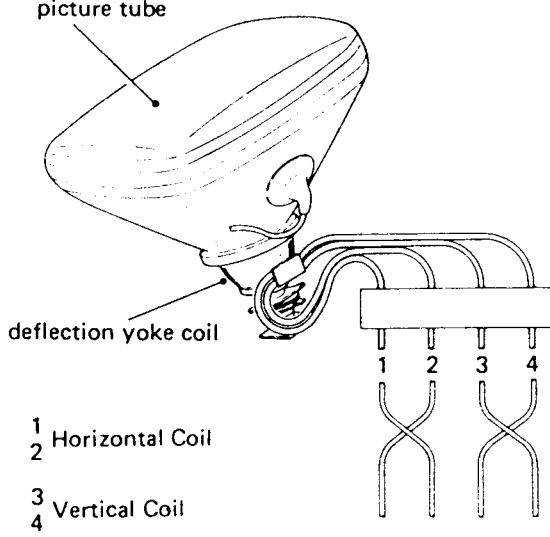

FIGURE 5b

USER INFORMATION
WARNING
F. C. C. REGULATION COMPLIANCE

"This equipment generates and uses radio frequency energy and if not installed properly, and used i.e., in strict accordance with the instructions manual, may cause harmful interference to radio communication. It has been tested and found to comply with the limit for a Class A Computing Device pursuant Subpart J of Part 15 of FCC Rules, which are designed to provide reasonable protection against such interference when operated in a commercial environment.

Operation of this equipment in a residential area is likely to cause interference in which case the user at his own expense will be required to take whatever measures may be required to correct the interference."

THE P.C. BOARD CAGE SUPPLIED WITH THIS CONVERSION KIT MUST BE UTILIZED AND TERMINATED TO GROUND AT THE TIME OF INSTALLATION.

FCC requires the STICKER below to be on the back of your machine or elsewhere visible when inspected .

"This equipment complies with the requirements for a Class A computing device in FCC Rules Part 15 Subpart J. Operation of this device in a residential area may cause harmful interference requiring the user to take whatever steps may be necessary to correct the interference."

1 LICENSE SEAL

The license seal can be displayed on the game machine as FIGURE 1. The license seal must be visible. Use caution so that the seal may not be peeled away thus losing the identity of the P.C. Board. Nichibutsu issues only one license seal for each board sold and no duplicates will ever be made. Put the seal on the back of the little window provide on our marquee or on the back of any clear glass or plastic overlay that you might be using.

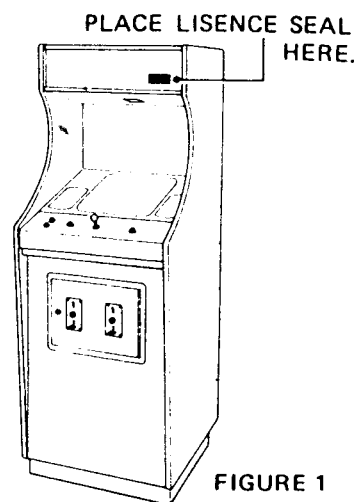

FIGURE 1

2 POWER REQUIREMENTS

The P.C. Board requires a power supply of
 + 5 V 3 A ($\pm 5\%$) for game logics,
 +12 V 1 A ($\pm 10\%$) for audio IC only.

3 CONTROL PANEL SECTION

A 8-way joystick and a shoot button are required.
 it will not work properly with a 4-way joystick.

4 COIN SELECTOR WIRING

A coin selector switch may be connected to either pin 13 (coin 1) or pin 14 (coin 2).

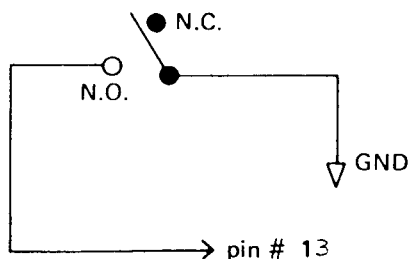

5 TV MONITOR

A color signal cable is provided to connect R.G.B. and SYNC signals from 6-pin connector located at right corner of the lower P.C. Board to the harness or to the TV Monitor directly.

Pin No.	Signal
1.	RED
2.	BLUE
3.	GREEN
4.	SYNC
5.	GND
6.	N.C.

TV monitor has to be equipped with TTL input level.
TV monitor must be placed vertical.

P.C. Board is designed to be used with "1-SYNC" signal monitor.
However, if your TV monitor has a "2-SYNC" signal connect as dotted line in FIGURE 3.

Pin #4 = V SYNC
Pin #6 = H SYNC

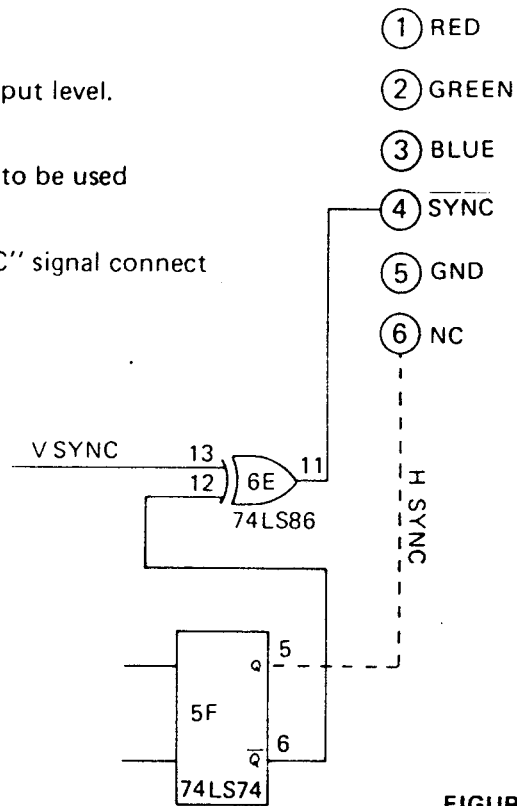
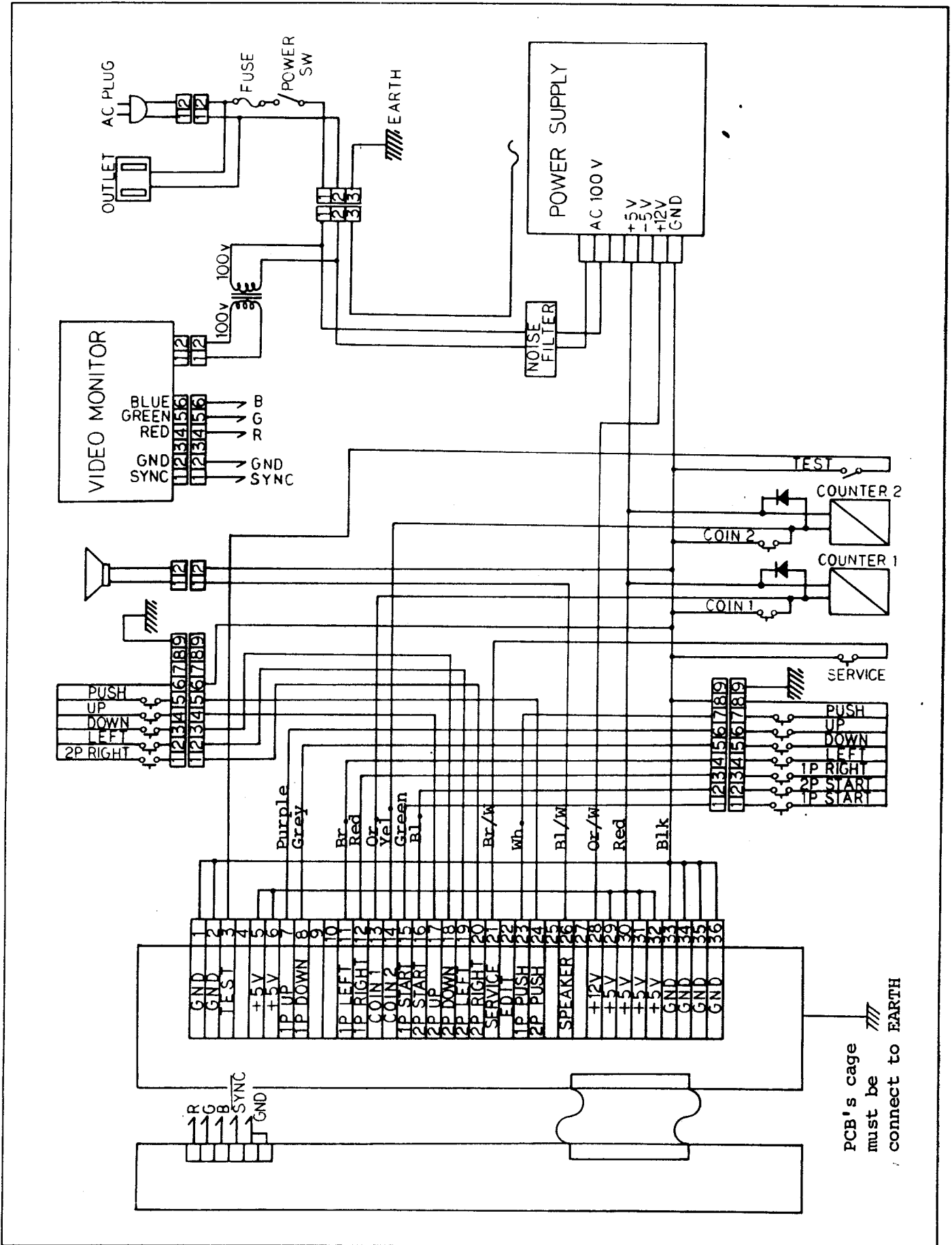
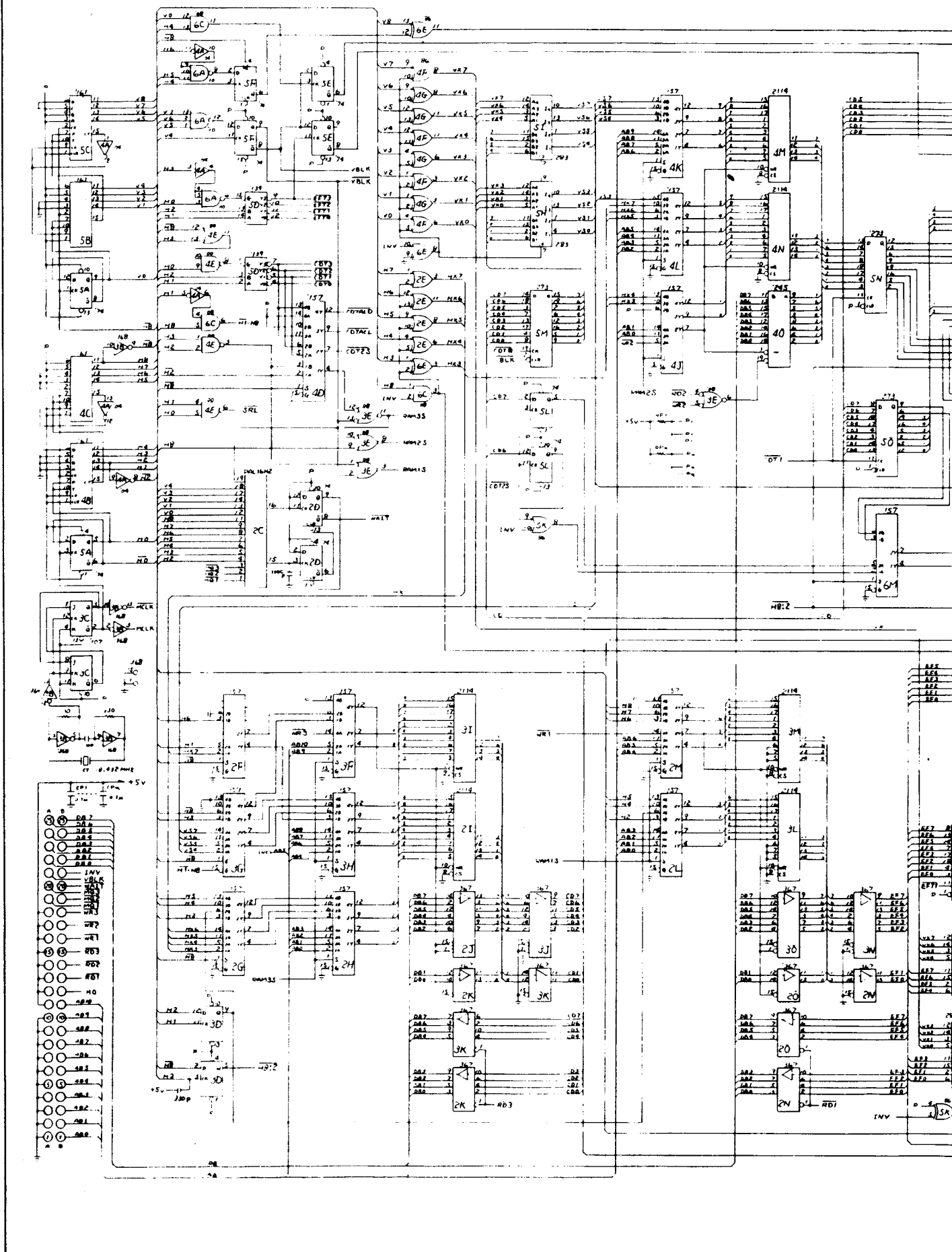

FIGURE 3

6 THE KITS INCLUDE

- | | | |
|----|-----------------------|------|
| A. | Instruction | 1 pc |
| B. | Print Circuit Board | 1 pc |
| C. | P.C.Board Cage | 1 pc |
| D. | License Seal | 1 pc |
| E. | Marquee | 1 pc |
| F. | Control Panel Overlay | 1 pc |
| G. | 36-Pin Connector | 1 pc |
| H. | Video Signal Cable | 1 pc |
| I. | Side Decal | 2 pc |





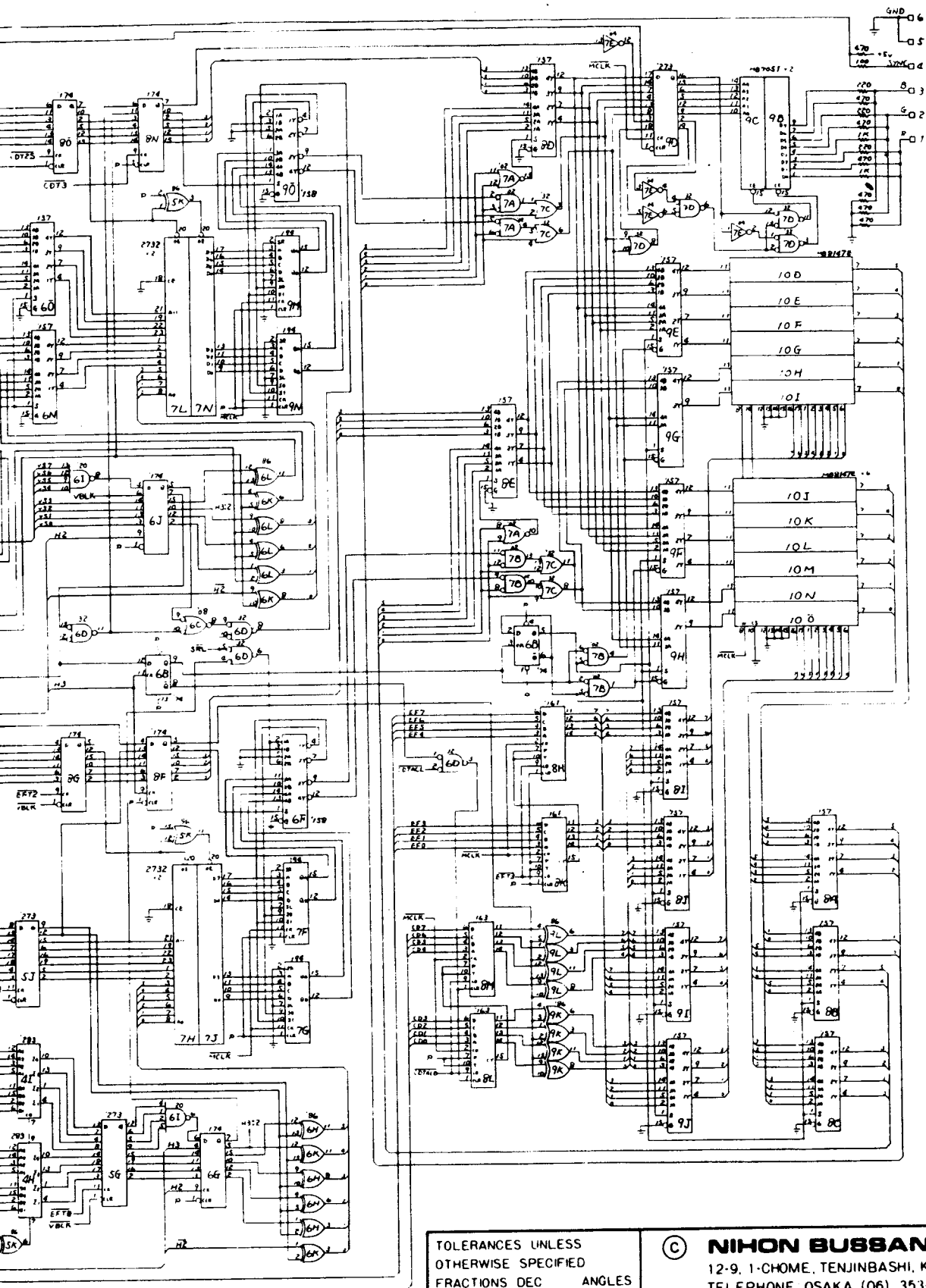

TOLERANCES UNLESS OTHERWISE SPECIFIED
 FRACTIONS DEC ANGLES

© **NIHON BUSSAN CO., LTD.**
 12-9, 1-CHOME, TENJINBASHI, KITA-KU, OSAKA, JAPAN
 TELEPHONE OSAKA (06) 353-5211
 TELEX: NCBCOL J523-6891

APPROVALS	DATE
DRAWN S.SAKURAI	

SEICROSS

SZ-1

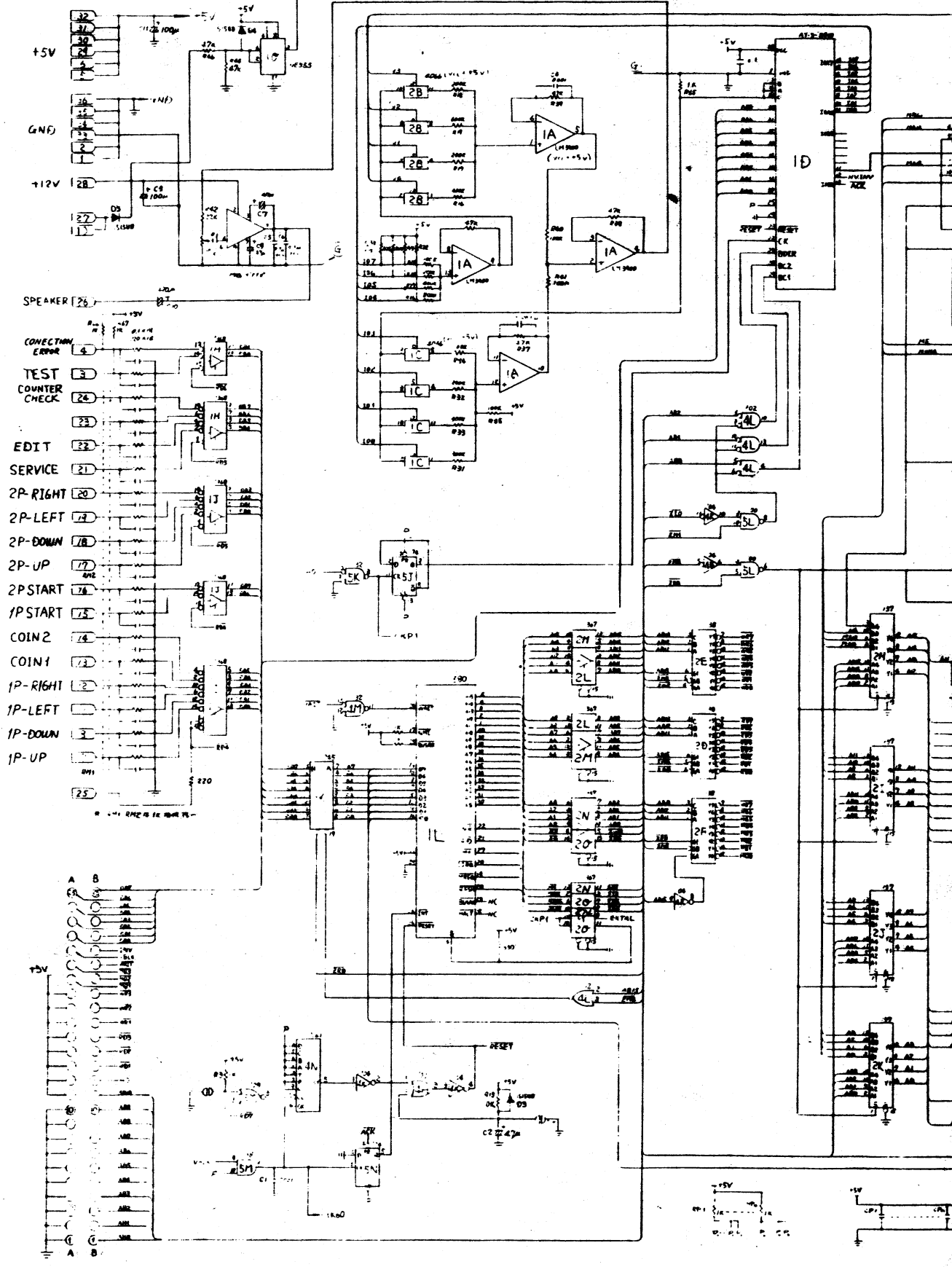

- CONNECTION ERROR
- TEST
- COUNTER CHECK
- EDIT
- SERVICE
- 2P-RIGHT
- 2P-LEFT
- 2P-DOWN
- 2P-UP
- 2P-START
- 1P-START
- COIN 2
- COIN 1
- 1P-RIGHT
- 1P-LEFT
- 1P-DOWN
- 1P-UP

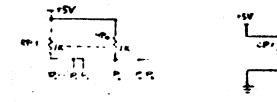
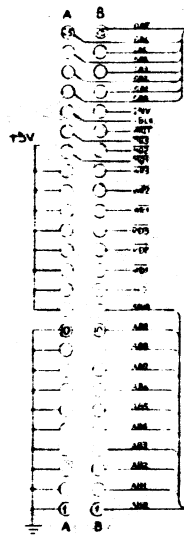

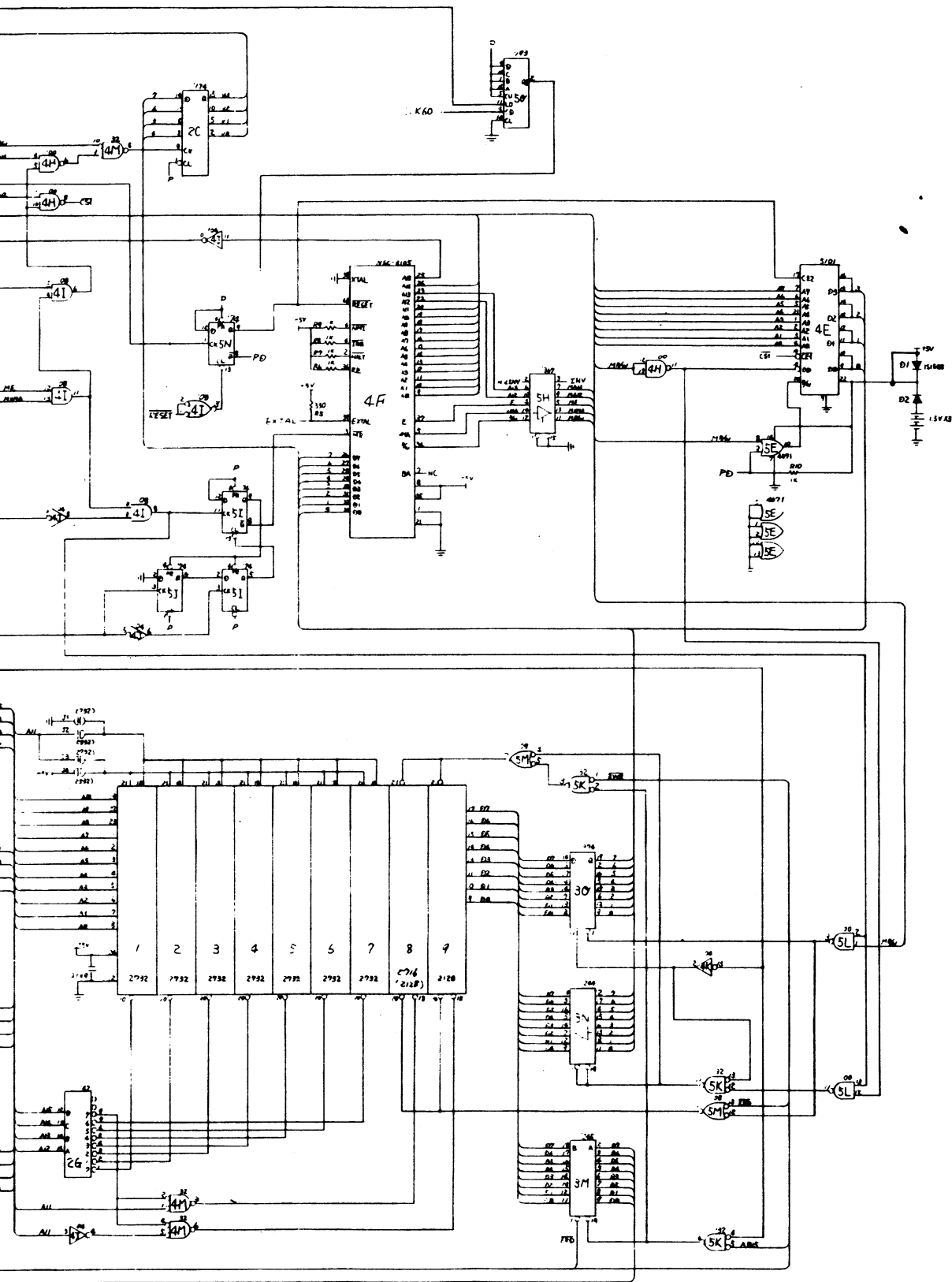

TOLERANCES UNLESS OTHERWISE SPECIFIED	
FRACTIONS	DEC
±	±
ANGLES	±
APPROVALS	DATE
DRAWN S.SAKURAI	

© **NIHON BUSSAN CO., LTD.**
 12-9, 1-CHOME, TENJINBASHI, KITA-KU, OSAKA, JAPAN
 TELEPHONE: OSAKA (06) 353-5211
 TELEX: NCBCOL J523-6891

SEICROSS

SZ-2



Nichibutsu
Nihon Bussan Co., Ltd.

Nichibutsu U.S.A. Corp.
15737 GARFIELD AVE.
UNIT #18
PARAMOUNT, CA 90723