

SEGA[®]

**SCRAMBLE
SPIRITS™**

OWNER'S MANUAL

SEGA ENTERPRISES, LTD.



TABLE OF CONTENTS

Introduction to the Owner's Manual.....	1
1. Handling Precautions	2
2. Prevention of Counterfeiting and Conversion	2
3. Precautions Concerning the Place of Installation	3
4. Disk Installation	4
5. Name of Parts	5
6. Adjustment of the Service Switch	6
7. Servicing the Power Supply Unit and Fuse	7
8. P.C. Board Assembly	7
9. Servicing the Floppy Disk	8
10. Drawing of P.C. Assembly	9
11. P.C. Board Component Locations	10
12. Monitor Adjustments and Game Board Servicing	11
13. Adjustment Instruction Switch Setting Sheet.....	12
14. Parts List	13
15. Schematic Diagram	14

SPECIFICATIONS

INSTALLATION SPACE	: 30 in. W × 37 in. D
HEIGHT	: 73 in.
POWER	: 201 W
C.R.T.	: 26 MONITOR
WEIGHT	: 140 kg (307 lbs.)

NOTE

- Descriptions herein contained may be subject to improvement changes without notice.

INTRODUCTION TO THE OWNER'S MANUAL

SEGA ENTERPRISES, LTD., supported by its high electronic technology of LSIs, microprocessors, etc. and a wealth of experience, has for more than 30 years been supplying various innovative and popular game machines to the world market. This OWNER'S manual is intended to provide detailed comments together with all the necessary information covering the operation in general of electronic assemblies, electromechanicals, servicing control, spare parts, etc. as regards the SCRAMBLE SPIRITS, a new SEGA product. The manual is intended for those who have knowledge of electricity and technical expertise especially in ICs, CRTs, microprocessors, etc. Carefully read so as to acquire sufficient knowledge before working on the machine. Should there be a malfunction, non-technical personnel should under no circumstances touch the interior system.

1. HANDLING PRECAUTIONS

When installing or inspecting, be very careful of the following points and pay attention to ensure that the player can enjoy the game safely.

- Be sure to turn the power off before working on the machine.
- To insert or pull out the plug quickly is dangerous.
- It is necessary to make sure that the power cord or the grounding wire is not exposed on the road, etc. in a manner so as to be dangerous. Make sure that grounding connections are made safely at the position where so specified.
- Do not use any fuse that does not meet the specified rating.
- Make complete connections for the IC board and other connectors. Insufficient insertion is very dangerous.
- For protection of the disk, please remove from machine prior to relocation.

Also, for the IC board circuit inspections, only the logic tone is allowed. The use of a tester is not permitted, so be careful in this regard. After confirming that there are no irregularities, turn the power ON.

2. PREVENTION OF COUNTERFEITING AND CONVERSION LABELLING

To prevent counterfeits and conversions, the following labels are put on all the SEGA products. When handling such goods, be sure to confirm the labels. They are used to prevent illegal acts such as the unauthorized copying of the products and the printed circuit boards thereof or carrying on business by manufacturing similar merchandise or by converting, selling or using such products or printed circuit boards.

ORIGINAL SEAL

The following seal is put on the machines manufactured by SEGA.



LICENSE SEAL

The following seal is put on the kits, such as the printed circuit boards, of SEGA products.



COPYRIGHT NOTICE

This SEGA product has the copyright notice as follows:

© SEGA 1988

This signifies that this work was disclosed in 1988 and is the property of SEGA ENTERPRISES, LTD.

3. PRECAUTIONS CONCERNING THE PLACE OF INSTALLATION

The SCRAMBLE SPIRITS is an indoor game machine. Absolutely do not install it outside. Even indoors, avoid installing in places mentioned below so as to ensure proper usage:

- Places subject to rain or water leakage, or condensation due to humidity.
- In the proximity of an indoor swimming pool and/or shower.
- Places subject to direct sunlight.
- Places subject to heat sources from heating units, etc., or hot air.
- Vicinity of highly inflammable/volatile chemicals or hazardous matter.
- Sloped surfaces.
- Vicinity of anti-disaster facilities such as fire exits and fire extinguishers.
- Places subject to any type of violent impact.
- Dusty places.

4. DISK INSTALLATION

IMPORTANT

INSTALLATION INSTRUCTIONS

SCRAMBLE SPIRITS contains a revolutionary new memory system for video games. This memory system is a Floppy Disk System which is housed in the RF Cage. This system allows Sega to give you more memory at a cost effective price.

To insure that no damage occurs to this delicate system during transit, we have packaged the Floppy Disk separately which must be installed upon receipt of the game. Please follow the listed instruction for the installation of the disk.

DISK INSTALLATION

1. Open Coin Door and remove Cash Box.
2. Open Cash Box and remove Floppy Disk. (NOTE: It is housed in a plastic protection cover.)
3. Reach thru the Coin Door opening and unlatch the two spring latches which hold the front assembly securely to the rear assembly of the game. These latches are located on the right, inside of the front assembly.
4. Once the two latches are unlocked, pull on the control panel assembly out for access to PCB RF cage.
5. Remove the cover of the PCB RF Cage by removing the four sheet metal screws.
6. Remove the two screws located on the left side of the wooden base of the PCB Assembly.
7. Lift the right side of the PCB Assembly. This will allow access to the disk drive, which is located underneath the PCB.
8. Remove the disk from the plastic protection case and install it into the disk drive label side up with the metal cover protection slide installed first. The disk should slide in and snap down to indicate that it is securely inserted.
9. Replace the two screws that you removed in Step #7 to secure the Wooden PCB base to the RF Cage.
10. Replace the lid of the RF Cage using the four sheet metal screws that were removed from the assembly in Step #6.
11. Close the control panel and latch.
12. Apply power to the game and verify proper operation. This completes the Drive Assembly.
13. For protection of the disk, please remove it from the machine prior to relocation.

5. NAME OF PARTS

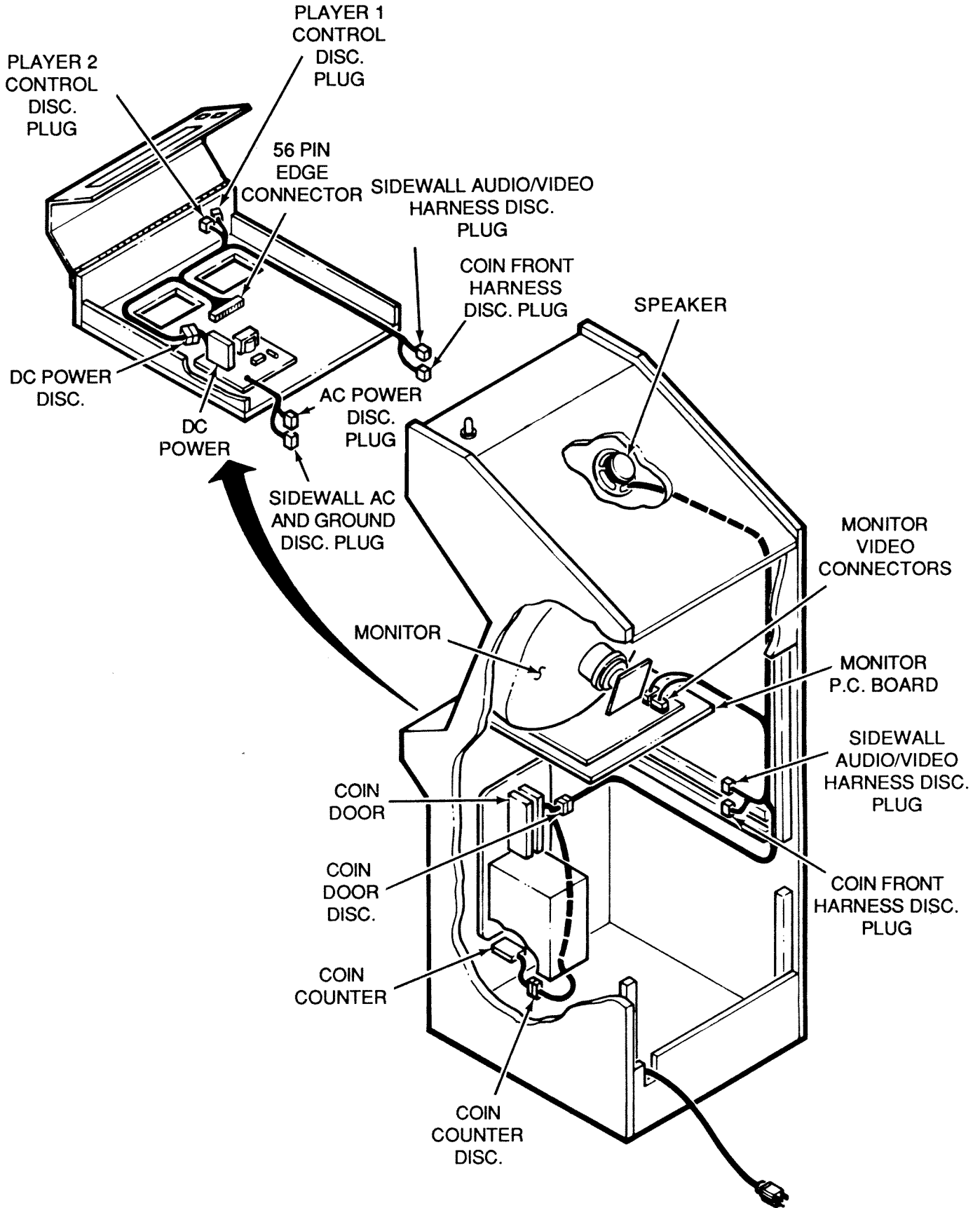

6. ADJUSTMENT OF THE SERVICE SWITCH

The layout as shown below can be viewed by opening the coin chute door.

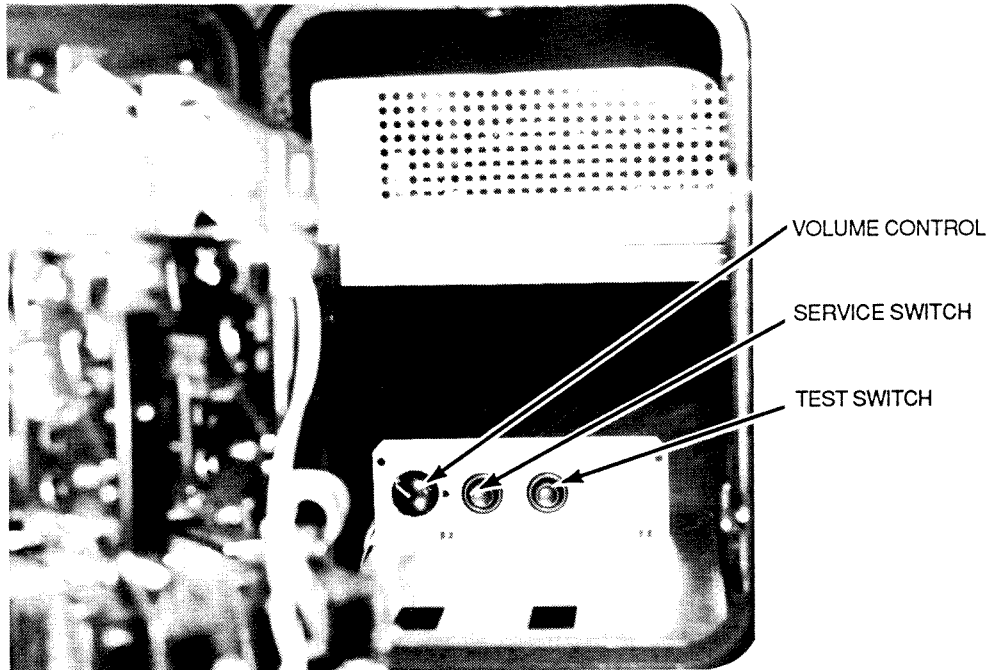

OPERATING INSTRUCTIONS

- SERVICE SWITCH** Used for the purpose of servicing and increasing the credits without registering on the meter (this allows you to check the game).
- TEST SWITCH** For operating this switch, see SELF-TESTING.
- VOLUME CONTROL** Potentiometer Adjustment

7. SERVICING THE POWER SUPPLY UNIT AND FUSE

Power Supply Assembly

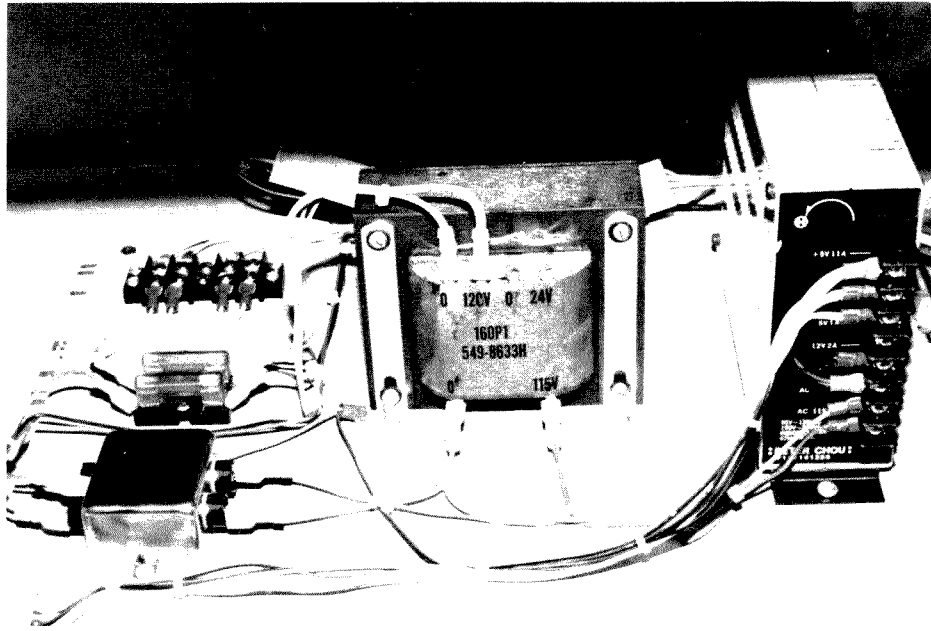

8. P.C. BOARD ASSEMBLY

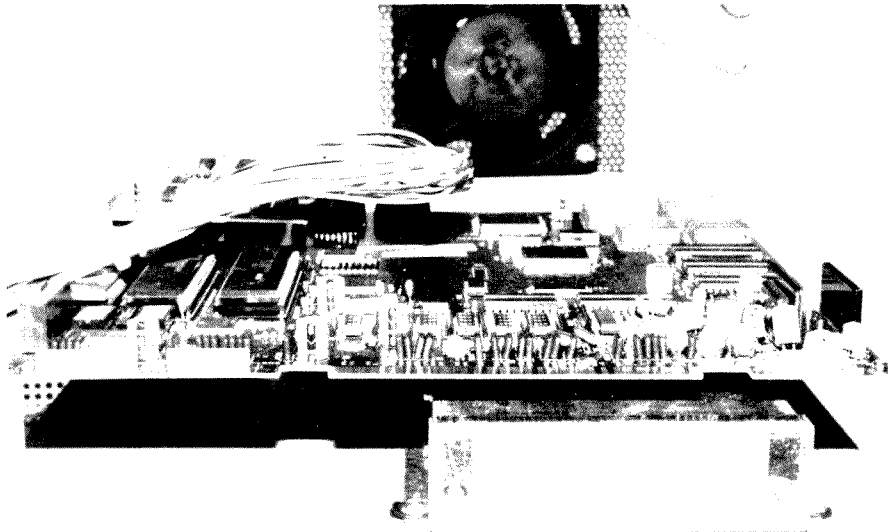

9. SERVICING THE FLOPPY DISK

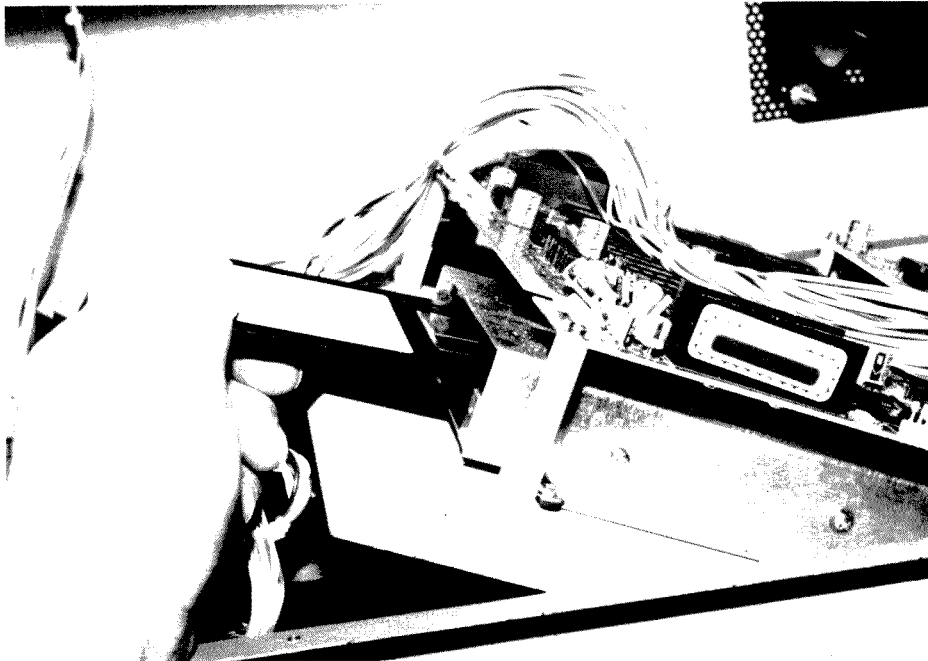

REMOVE THE LID of the SHIELD CASE. Remove the sheet metal and pull out the game board unit in a manner so that both ends of it will meet the shield case. Open the FDD (Floppy Disk Drive) LID by taking off the 2 (M3 x 8) SCREWS when replacing the FLOPPY DISK.

10. DRAWING OF PC ASSEMBLY

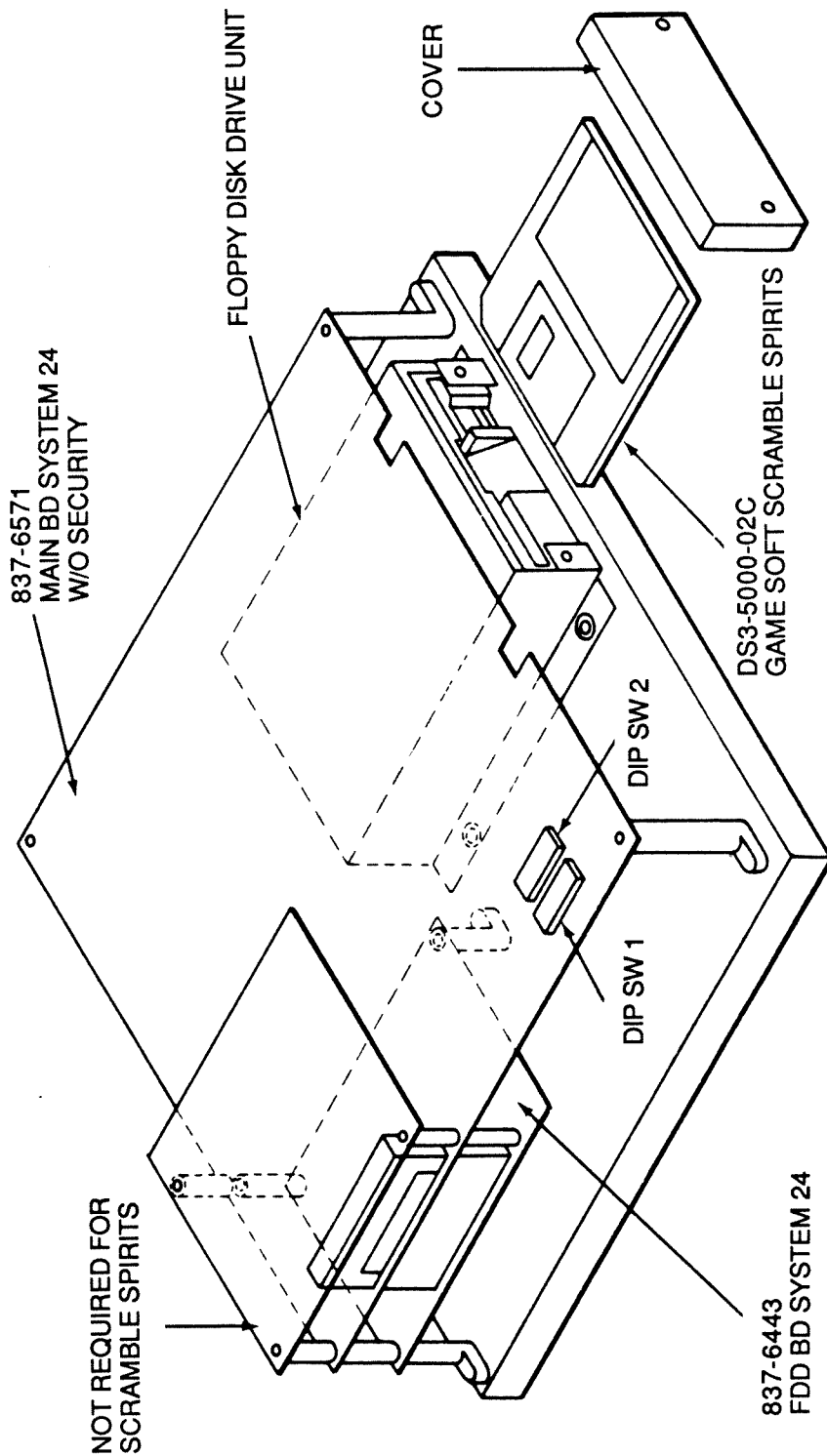

11. PC BOARD COMPONENT LOCATIONS

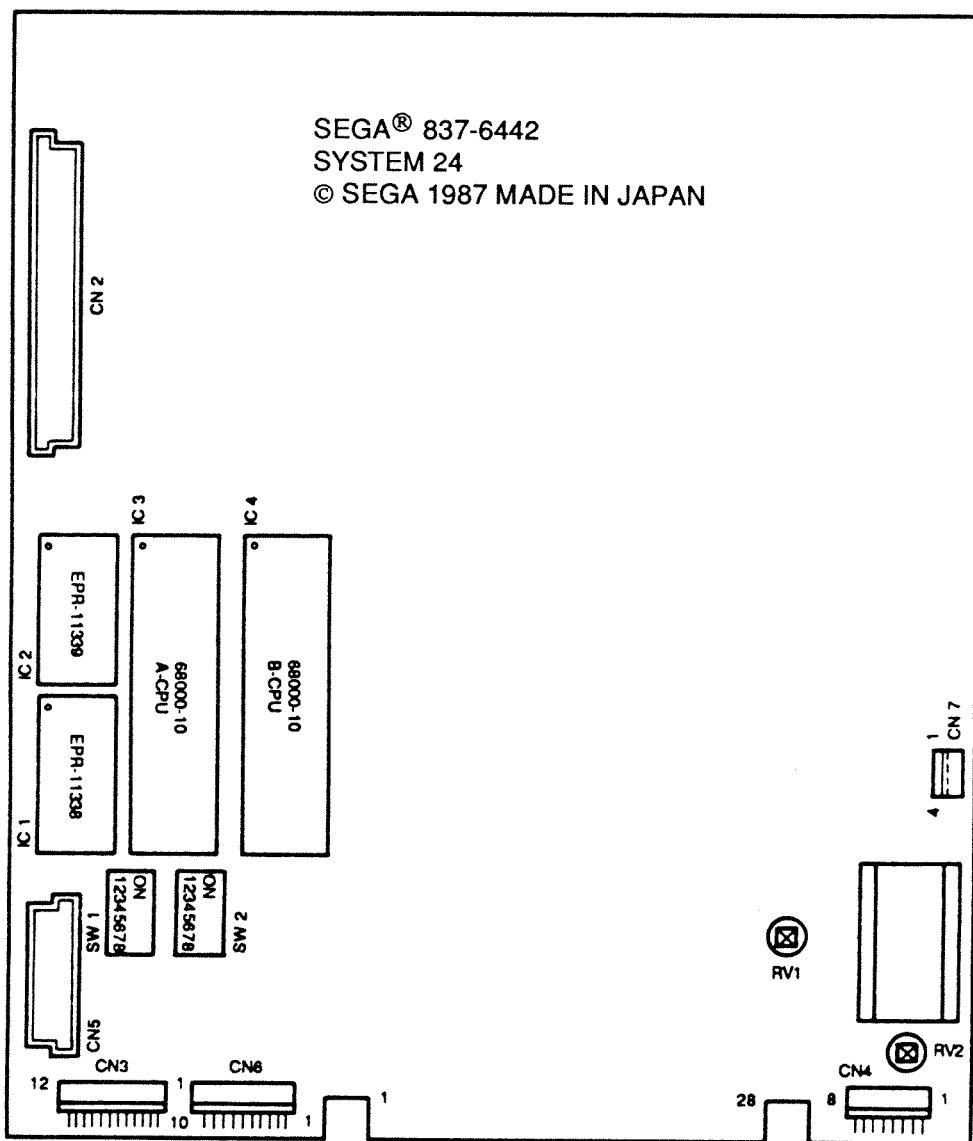

MAIN BD SY 24

- IC 1 EPR-11338 (IC MB27C1000-15)
- IC 2 EPR-11339 (IC MB27C1000-15) FOR SYSTEM
- IC 3 IC 6800
- IC 4 IC SECURITY CPU 68000 OR IC 68000 FOR GAME PROGRAM
- SW 1 DIP SW
- SW 2 DIP SW
- CN 3 DATA COMMUNICATION CONNECTOR
- CN 6 RESERVE POWER CONNECTOR
- CN 7 INPUT (SOUND) CONNECTOR
- CN 8 HEADPHONE OUTPUT CONNECTOR
- RV 1 MAIN SOUND VOLUME
- RV 2 HEADPHONE SOUND VOLUME

12. MONITOR ADJUSTMENT AND GAME BOARD SERVICING

Monitor Adjustment

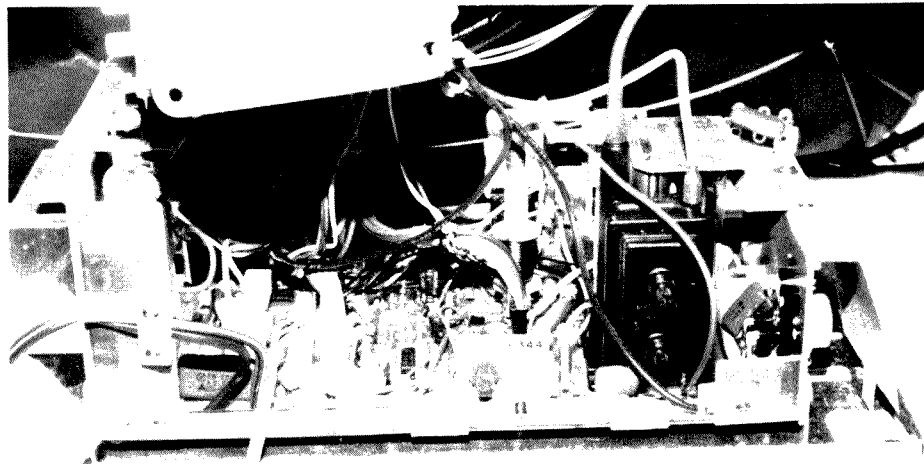

Scramble Spirits Printed Circuit Board

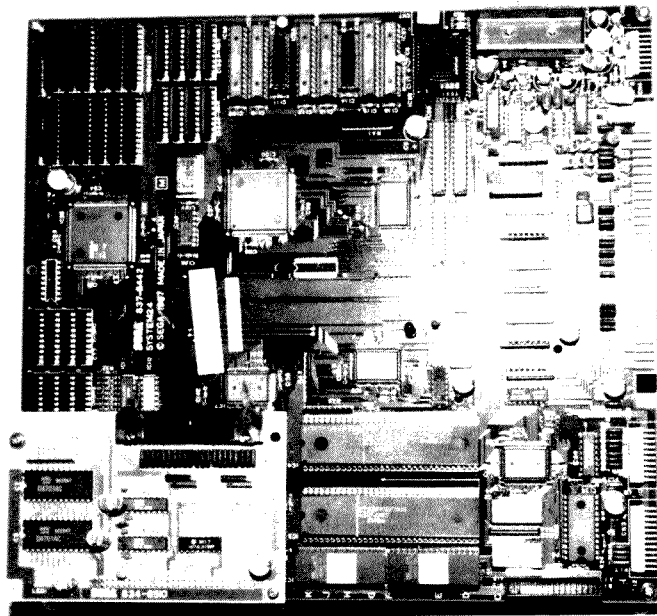

13. ADJUSTMENT INSTRUCTION SWITCH SETTING SHEET

SCRAMBLE SPIRITS (834-6570-02)

COIN/CREDIT OPTION SWITCH SETTING

OPTION	DIP SW #1							
	1	2	3	4	5	6	7	8
1 COIN	OFF	OFF	OFF	OFF	OFF	OFF	OFF	OFF
2 CREDITS	ON	OFF	OFF	OFF	OFF	OFF	OFF	OFF
3 CREDITS	ON	ON	OFF	OFF	OFF	OFF	OFF	OFF
4 CREDITS	ON	ON	OFF	OFF	OFF	OFF	OFF	OFF
5 CREDITS	ON	ON	OFF	OFF	OFF	OFF	OFF	OFF
6 CREDITS	ON	ON	OFF	OFF	OFF	OFF	OFF	OFF
1 COIN	ON	ON	ON	ON	ON	ON	ON	ON
2 COINS	ON	ON	ON	ON	ON	ON	ON	ON
3 COINS	ON	ON	ON	ON	ON	ON	ON	ON
4 COINS	ON	ON	ON	ON	ON	ON	ON	ON
2 COINS	ON	ON	ON	ON	ON	ON	ON	ON
4 COINS	ON	ON	ON	ON	ON	ON	ON	ON
5 COINS	ON	ON	ON	ON	ON	ON	ON	ON
6 COINS	ON	ON	ON	ON	ON	ON	ON	ON
2 COINS	ON	ON	ON	ON	ON	ON	ON	ON
4 COINS	ON	ON	ON	ON	ON	ON	ON	ON
1 COIN	ON	ON	ON	ON	ON	ON	ON	ON
2 COINS	ON	ON	ON	ON	ON	ON	ON	ON
3 COINS	ON	ON	ON	ON	ON	ON	ON	ON
4 COINS	ON	ON	ON	ON	ON	ON	ON	ON
1 COIN	ON	ON	ON	ON	ON	ON	ON	ON
2 COINS	ON	ON	ON	ON	ON	ON	ON	ON
FREE PLAY	ON	ON	ON	ON	ON	ON	ON	ON

PIN ASSIGNMENT	
COMPONENT SIDE	SOLDER SIDE
1	A
2	B
3	C
4	D
5	E
6	F
7	H
8	J
9	K
10	L
11	M
12	N
13	P
14	R
15	S
16	T
17	U
18	V
19	W
20	X
21	Y
22	Z
23	a
24	b
25	c
26	d
27	e
28	f

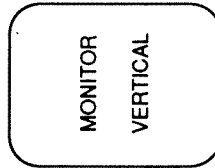
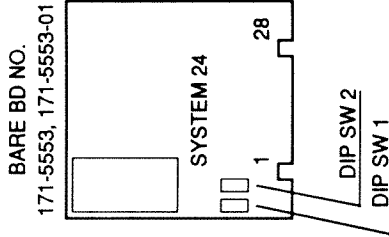

GAME OPTION SWITCH SETTING

OPTION	DIP SW #2							
	1	2	3	4	5	6	7	8
DISPLAY FLIP	OFF	ON						
ADVERTISE SOUND	OFF	ON						
INITIAL SHIPS			OFF	OFF				
BONUS SHIP						OFF	OFF	
NO BONUS						ON	ON	
NORMAL								OFF
EASY								ON
HARD								OFF
HARDEST								ON

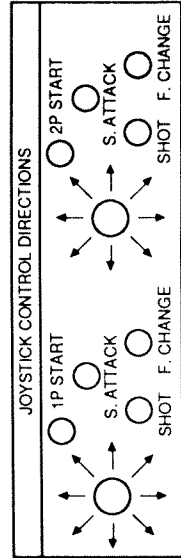

S. ATTACK: SPECIAL ATTACK
F. CHANGE: FORMATION CHANGE

56P P : 3.96mm

421-7339

14. PARTS LIST

SEGA SUPPLIED COMPONENTS

PART NUMBER	DESCRIPTION	QTY
117-5123	NAME PLATE	1
2001-5125-24	MONITOR, 26" MID RES	1
4201-0004	MANUAL, SCRAMBLE SPIRITS	1
421-5800-86	ORIGINAL SEAL, SCRAMBLE SPIRITS	1
421-6594	SERIAL NO. STICKER	1
4211-7228	STICKER, SWITCH UNIT	1
4231-0015	MARQUEE, SCRAMBLE SPIRITS	1
4231-0016	MONITOR BEZEL	1
4231-0017	CONTROL INSERT, SCRAMBLE	1
4231-0018	DECAL, LEFT SIDE SCRAMBLE	1
4231-0019	DECAL, RIGHT SIDE SCRAMBLE	1
4231-0020	INSTR. STICKER LEFT, SCRAMBLE	1
4231-0021	INSTR. STICKER RIGHT, SCRAMBLE	1
4750-0049	RHEOSTAT, 100 OHM 10W	1
5090-5028	SWITCH, PB MOM.	2
5091-0001	JOY STICK 8 WAY (SPRING TYPE)	2
5091-0005-01	PB, RED (MS)	2
5091-0005-02	PB, WHITE (MS)	2
5091-0005-04	PB, YELLOW (MS)	4
6010-0043	KNOB, 1/8" SHAFT	1
610-0198	ASSY, FDD UNIT	1
834-6570	GAME PCB, SYSTEM 24	1
DC3-5000-02C	GAME SOFTWARE, SCRAMBLE	1
HL-4202	FDD BASE	1
HL-4203	FDD COVER	1
HL-4204	FDD LID	1
HL-4205	SASH RUBBER 110	1
HL1-4101	SHIELD CASE	1
HL1-4102	SHIELD LID	1
UP1-0008	SERVICE SWITCH BRKT	1

DYNAMO SUPPLIED COMPONENTS

PART NUMBER	DESCRIPTION	QTY
XA800001300	COVER, SPEAKER	1
XA801500100	PANEL, CONTROL HS5	1
XA801500200	BRACKET, MARQUEE	1
XA880000100	SOCKET, LAMP DBL #22253	1
XA880000201	POWER SUPPLY 5V 11A, 12V 2A	1
XA880000301	HOLDER, FUSE #S-8202-2	1
XA880000401	FILTER, EMI AC LINE	1
XA880000501	FUSE, 7 AMP 250V #312007	1
XA880000600	SPEAKER, 5" 8 OHMS	1
XA880001100	HOUSING, COIN (10-1397-09)	1
XA880001800	BULB, LIGHT 40W CLEAR #04111	2
XA880002200	ISOLATION TRANSFORMER	1
XA890001500	LEVELER, LEG (331517)	4
XA911500100	GLASS, TEMP NM 1/4X25.75X25.75	1
XA990001400	ASSY, POWER CORD	1

15. SCHEMATIC DIAGRAM

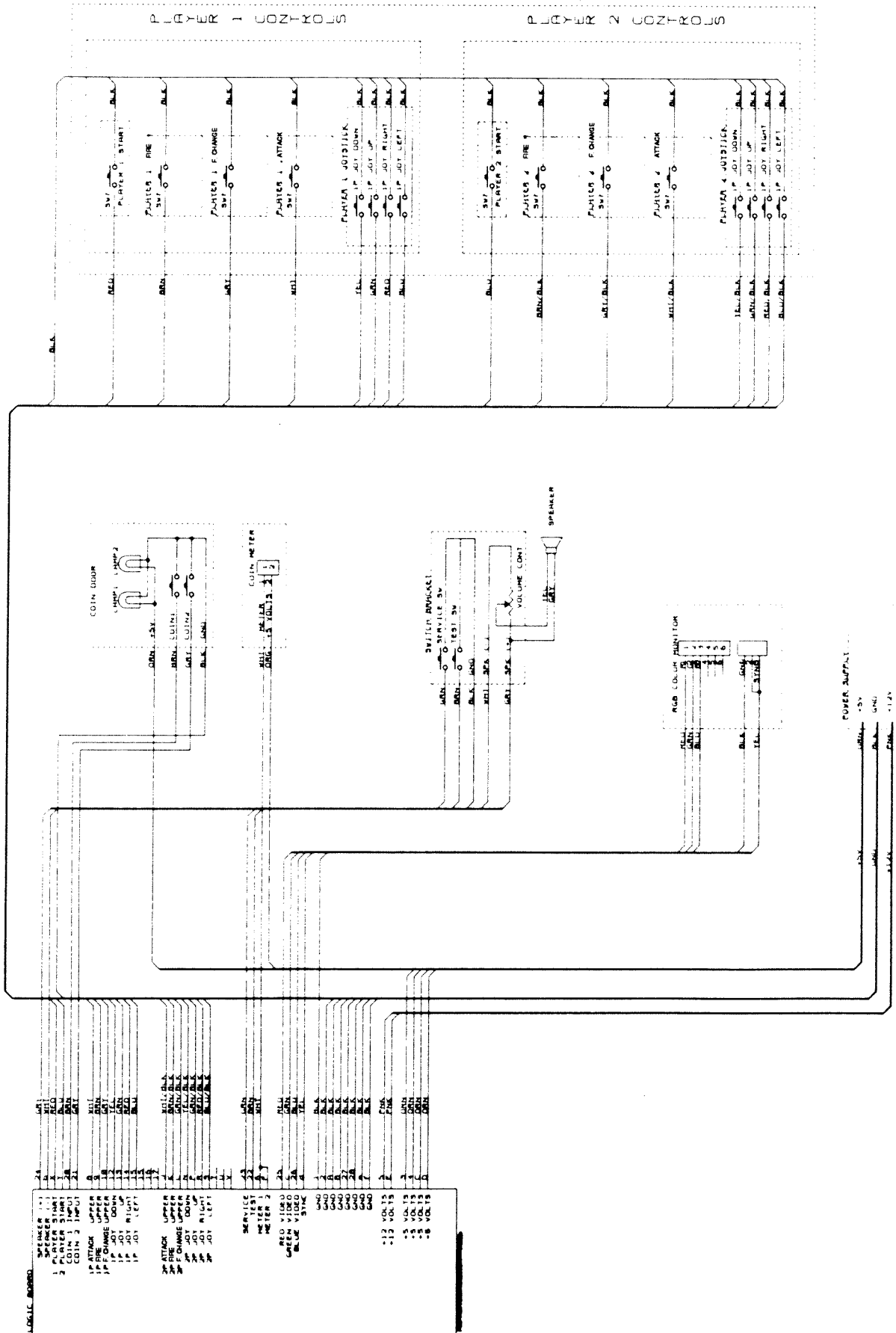

SEGA ENTERPRISES, INC. (USA)
2149 Paragon Drive
San Jose, CA 95131
Tel. (408) 435-0201
©SEGA 1988