

FIRST PRINTING OCTOBER 1996



SERVICE MANUAL

MANUAL NO. DYNN-00635



SEGA *GameWorks*

Welcome to the Service Department Home Page



**The following options
are available to you :**

- **Look up your local Sega Distributor**
- **Go to Individual Manuals and Bulletins**
- **Find an Individual Part Number**
- **Find a Manual Part Number**
- **Get Info on your Game Monitor**
- **Get Info on your Board System**
- **Talk to the Service Staff**
- **Sign up to Receive Service Bulletins**
- **What is going on in Darl's Office**

Sega GameWorks Service Department

**Phone (415)-802-1750
Fax (415)-802-1754**

If you have any questions about this Home Page please E-Mail to:
darl.davidson@sega.com



COPYRIGHT NOTICE

This SEGA product has a copyright notice as follows:

© 1996 Sega Enterprises, Inc. (USA) All rights reserved.

This signifies that this work was disclosed in 1996 and is the property of
SEGA ENTERPRISES, INC. (USA).

Every effort has been made to ensure that this manual is accurate. Sega Enterprises, Inc. (USA) is not liable for any printing or clerical errors.

Specifications noted herein are subject to change without notice.

Contents

INTRODUCTION OF THE OWNER'S MANUAL	
SAFETY CERIFICATION AND GENERAL PRECAUTIONS	2
HANDLING PRECAUTIONS	2
INSTALLATION LOCATION PRECAUTIONS	3
SPECIFICATIONS	4
INSTALLATION ITEMS AND HARDWARE	5
ASSEMBLING THE MACHINE	6
LEG LEVELERS	7
POWER-ON CHECKS	8
EXPLANATION OF TEST AND DATA DISPLAY	10
SERVICE PANEL	11
TEST MODES	12
COIN/CREDIT TABLES	18
COIN MECH ADJUSTMENTS AND CARE	27
MONITOR ADJUSTMENT	28
PERIODIC INSPECTION ITEMS	30
TROUBLE SHOOTING	31
GAME BOARD	33
GAME BOARD SERVICE RECORD	35
DESIGN RELATED PARTS	36
PARTS IDENTIFICATION	37
MANUAL COMMENTS	45
WIRING DIAGRAM/SCHEMATIC	46

INTRODUCTION OF THE OWNERS MANUAL

SEGA ENTERPRISES, LTD., has for more than 30 years been supplying various innovative and popular amusement products to the world market. This Owners Manual is intended to provide detailed descriptions together with all the necessary installation, game settings and parts ordering information related to the **DAYTONA USA SPECIAL EDITION**, a new SEGA product.

This manual is intended for those who have knowledge of electricity and technical expertise, especially in ICs, CRTs, microprocessors, and circuit boards. Read this manual carefully to acquire sufficient knowledge before working on the machine. Should there be a malfunction, non-technical personnel should under no circumstances touch the interior system. Should the need arise, contact our main office, or the closest branch office listed below.

SEGA ENTERPRISES, INC. (USA)

Customer Service

45133 Industrial Drive

Fremont, CA 94538

Phone 415-802-1750

Fax 415-802-1754

7:30 am - 4:00 pm, Pacific Standard Time

Monday thru Friday

General Precautions

Follow Instructions: All operating and use instructions should be followed.

Attachments: Do not use attachments not recommended by the product manufacturer as they may cause hazards.

Accessories: Do not place this product on an unstable cart, stand, tripod, bracket, or table. The product may fall, causing serious injury to a child or adult, and serious damage to the product. Use only with a cart, stand, tripod, bracket, or table recommended by the manufacturer, or sold with the product. Any mounting of the product should follow the manufacturer's instructions, and should use only mounting accessories recommended by the manufacturer.

Moving the Product: This product should be moved with care. Quick stops, excessive force, and uneven surfaces may cause the product to overturn.

Ventilation: Slots and openings in the cabinet are provided for ventilation, to ensure reliable operation of the product and to protect it from overheating; these openings must not be blocked or covered. The openings should never be blocked by placing the product in a built-in installation such as a bookcase or rack unless proper ventilation is provided or the manufacturer's instructions have been adhered to.

Power Sources: This product should be operated only from the type of power source indicated on the marking label. If you are not sure of the type of power supply to your location, consult your local power company. For products intended to operate from battery power or other sources, refer to the operating instructions.

Grounding or Polarization: This product is equipped with a three-wire grounding-type plug, a plug having a third (grounding) pin. This plug will only fit into a grounding-type power outlet. This is a safety feature. If you are unable to insert the plug into the outlet, contact your electrician to replace your obsolete outlet. Do not defeat the safety purpose of the grounding-type plug.

Power Cord Protection: Power-supply cords should be routed so that they are not likely to be walked on or pinched by items placed upon or against them, paying particular attention to cords at plugs, convenience receptacles, and the point where they exit from the product.

Overloading: Do not overload wall outlets, extension cords, or integral convenience receptacles as this can result in a risk of fire or electric shock.

Object and Liquid Entry: Never push objects of any kind into this product through openings as they may touch dangerous voltage points or short-out parts that could result in a fire or electric shock. Never spill liquid of any kind on the product.

Servicing: Do not attempt to service this product yourself as opening or removing covers may expose you to dangerous voltage or other hazards. Refer all servicing to qualified service personnel.

Damage Requiring Service: Unplug this product from the wall outlet and refer servicing to qualified service personnel under the following conditions:

- a) If the power cord or plug is damaged;
- b) If liquid has been spilled, or objects have fallen into the product;
- c) If the product has been exposed to rain or water;
- d) If the product does not operate normally when following the operating instructions. Adjust only those controls that are explained in the operating instructions. An improper adjustment of other controls may result in damage and will often require extensive work by a qualified technician to restore the product to its normal operation;
- e) If the product has been dropped or damaged in any way;
- f) When the product exhibits a distinct change in performance; this indicates a need for service.

Replacement Parts: When replacement parts are required, be sure the service technician has used replacement parts specified by the manufacturer or that have the same characteristics as the original part. Unauthorized substitutions may result in fire, electric shock, or other hazards.

Safety Check: Upon completion of any service or repairs to this product, ask the service technician to perform

safety checks to determine that the product is in proper operating condition.

Heat: The product should be situated away from heat sources such as radiators, heat registers, stoves, or other products (including amplifiers) that produce heat.

Cleaning: When cleaning the monitor glass, use water or glass cleaner and a soft cloth. Do not apply chemicals such as benzine, thinner, etc.

Location: This an indoor game machine, DO NOT install it outside. To ensure proper usage, avoid installing indoors in the places mentioned below:

- Places subject to rain/water leakage, or condensation due to humidity;
- In close proximity to a potential wet area;
- Locations receiving direct sunlight;
- Places close to heating units or hot air;
- In the vicinity of highly inflammable/volatile chemicals or hazardous matter;
- On sloped surfaces;
- In the vicinity of emergency response facilities such as fire exits and fire extinguishers;
- Places subject to any type of violent impact;
- Dusty places.

INSTALLATION PRECAUTIONS

- Verify the amperage of the branch circuit outlet before plugging in the power plug. Do not overload the circuit.
- Avoid using an extension cord. If one is required, use an extension cord of type SJT, 16/3 AWG rated min. 120 VAC, 7A.
- Moving this unit requires a minimum clearance (of doors, etc.) of 32" (W) by 77" (H).
- For the operation of this machine, secure a minimum area of 32" (W) by 42"(D).

REGULATORY APPROVALS

This game has been tested and found to comply with the Federal Communications Commission Rules.

This device complies with Part 15 of the FCC Rules. Operation is subject to the following two conditions: (1) This device may not cause harmful interference, and (2) this device must accept any interference received, including interference that may cause undesired operation.

This game has been tested and listed by Underwriters Laboratories, Inc., to ANSI/UL22.

LISTED



AMUSEMENT MACHINE

SPECIFICATIONS

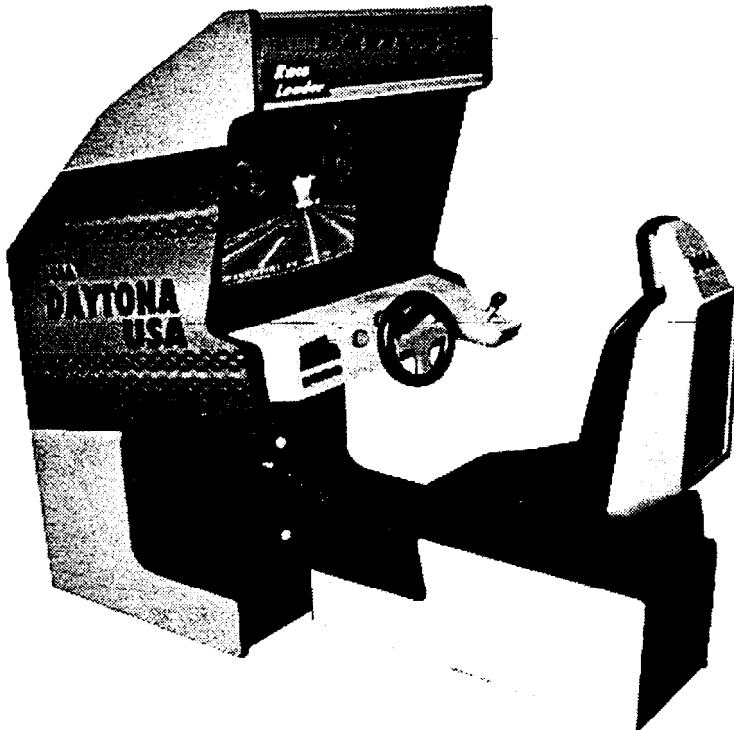

Seat Assembly

	Width	Length	Height	Weight
Crated	24.25"	42.5"	47"	140 lbs
Assembled	21.25"	38"	44.5"	120 lbs

Monitor Assembly

	Width	Length	Height	Weight
Crated	35.5"	43.5"	73"	450 lbs
Assembled	31.75"	39"	70"	430 lbs

Monitor 26" Wells Gardner Monitor 25K5191
Power AC 345W 3A

INSTALLATION AND HARDWARE

When transporting the machine, make sure that the following parts are supplied.

QTY.	DESCRIPTION
2	Key, Coin Mech Door
2	Key, Cash Box (Behind Coin Mech Door)
2	Key, Rear Service Door (Behind Coin Mech Door)
1	Owners manual, Daytona
1	Fiber Optic Cable
1	Wrench, T-20 torx tamperproof
1	Wrench, T-27 torx tamperproof
1	Wrench, T-15 torx tamperproof

PERFORM THE ASSEMBLY WORK BY FOLLOWING THE PROCEDURE STATED HEREIN. FAILURE TO COMPLY WITH THESE INSTRUCTIONS CAN RESULT IN ELECTRIC SHOCK.

WHEN ASSEMBLING, BE SURE THAT TWO OR MORE PERSONS ARE AVAILABLE TO PERFORM THE WORK. IN SOME CASES, ATTEMPTING THE ASSEMBLY WORK ALONE CAN RESULT IN INJURY OR DAMAGE TO THE GAME AND ITS PARTS.

When carrying out the installation instructions, follow the sequence outlined below.

1. **Connect the cabinets.**
2. **Secure in place**
2. **Connect power supply**
3. **Perform the assembly check**

Note that for installation work, a master key and other hardware are required. Refer to the preceding list of installation items.

CONNECT THE CABINETS

The brackets for connecting the seat and monitor cabinets are shipped attached to the game. All hardware is attached to the brackets at the time of shipping.

To assemble the two cabinets, remove all retaining hardware and move the cabinets to their installation position.

Bring the seat and monitor cabinets together, at the installation position.

Align the connection bracket on the seat and monitor cabinets and fasten securely with the hardware provided.

To move the game, first disassemble the connecting bracket. Do not attempt to move the game with the cabinets connected. To do so can cause damage to the cabinets and bracket assembly.

SECURING IN PLACE (LEG ADJUSTERS)

This machine has 2 casters and 8 leg adjusters. When the installation position is determined, cause the leg adjusters to come into contact with the floor, and make adjustments so that the casters are raised approximately 5 mm. above the floor, and the machine is level.



Make sure that all of the leg adjusters are in contact with the floor. If they are not, the cabinet can move causing an accident.

Move the machine to the installation position. When installing the machine against or close to a wall, be sure to secure a passage space to enable the player to take a ride in the machine.

Have the leg adjusters make contact with the floor. To keep the machine level, adjust the height of the leg adjuster upward using a wrench.

After making adjustments, fasten the leg adjuster nut upward and secure the height of the leg adjuster.

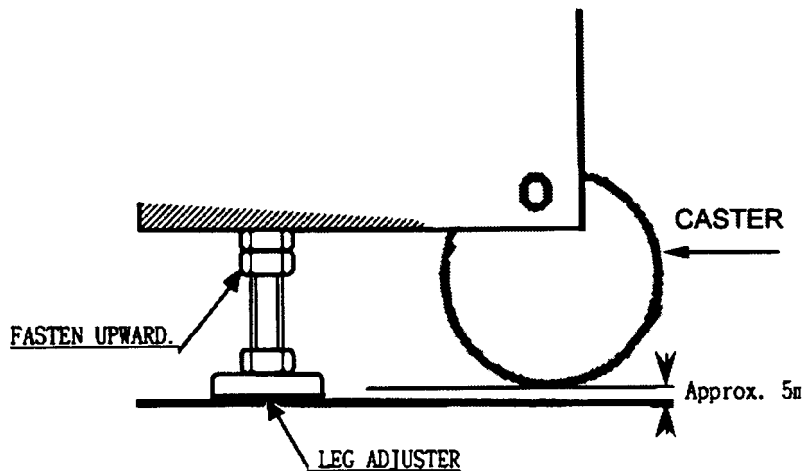

(1) MEMORY TEST

MEMORY TEST							
-ROM- ROM BOARD							
IC6	GOOD	IC7	GOOD				
IC8	GOOD	IC9	GOOD				
IC10	GOOD	IC11	GOOD				
IC12	GOOD	IC13	GOOD				
-RAM- CPU BOARD							
IC12	GOOD	IC13	GOOD	IC14	GOOD	IC15	GOOD
IC16	GOOD	IC17	GOOD				
IC41	GOOD	IC42	GOOD	IC43	GOOD	IC44	GOOD
IC86	GOOD	IC88	GOOD				
-RAM- VIDEO BOARD							
IC30	GOOD	IC31	GOOD	IC32	GOOD	IC33	GOOD
IC35	GOOD	IC36	GOOD	IC37	GOOD	IC38	GOOD
IC39	GOOD	IC40	GOOD	IC41	GOOD	IC42	GOOD
IC43	GOOD	IC46	GOOD	IC48	GOOD		
IC47	GOOD	IC48	GOOD	IC49	GOOD	IC50	GOOD
IC84	GOOD	IC86	GOOD				
IC87	GOOD	IC88	GOOD	IC89	GOOD		
IC76	GOOD	IC78	GOOD	IC77	GOOD	IC78	GOOD
IC79	GOOD	IC80	GOOD	IC81	GOOD	IC82	GOOD
PRESS TEST BUTTON TO EXIT							

Assembly Check

In the Test mode, ascertain that the assembly has been made correctly and IC Board is satisfactory.

In the test mode, perform the following tests:

1. Memory Test

Selecting the Memory Test on the test mode menu screen causes the on-board memory to be tested automatically. The game board is satisfactory if the display beside each IC number shows GOOD.

(2) INPUT TEST

INPUT TEST	
MACHINE GUN	OFF
MISSILE	OFF
VIEW CHANGE	OFF
STICK LR	8H
STICK UL	9H
START	OFF
COIN CHUTE #1	OFF
COIN CHUTE #2	OFF
SERVICE	OFF
TEST	OFF
PRESS TEST BUTTON TO EXIT	

2. Input Test

Selecting the Input Test on the test mode menu screen causes the screen (on which each switch is tested) to be displayed. Press each switch. For the coin switch test, insert a coin from the coin inlet with the coin chute door open. If the display beside each switch indicates ON, the switch and wiring connections are satisfactory.

(3) OUTPUT TEST

OUTPUT TEST	
START LAMP	OFF
VIEW CHANGE LAMP	OFF
DANGER LAMP	OFF
-- EXIT	
SELECT WITH SERVICE BUTTON AND PRESS TEST BUTTON	

3. Output Test

In the Output Test mode, carry out the lamp test to ascertain that each lamp lights up satisfactorily.

(4) SOUND TEST

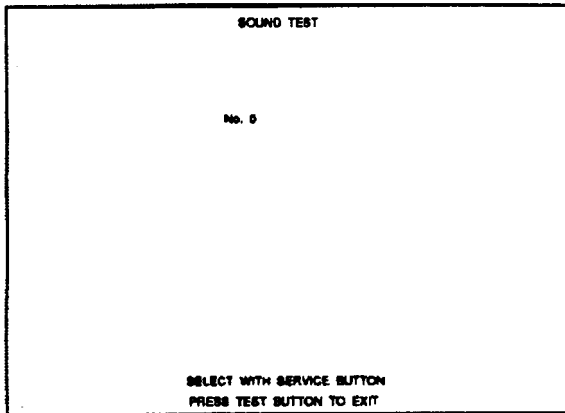

4. Sound Test

In the Test mode, selecting Sound Test causes the screen (on which sound-related board and wiring connections are tested) to be displayed.

Be sure to check if the sound is satisfactorily emitted from each speaker and the sound volume is appropriate.

(5) C.R.T. TEST

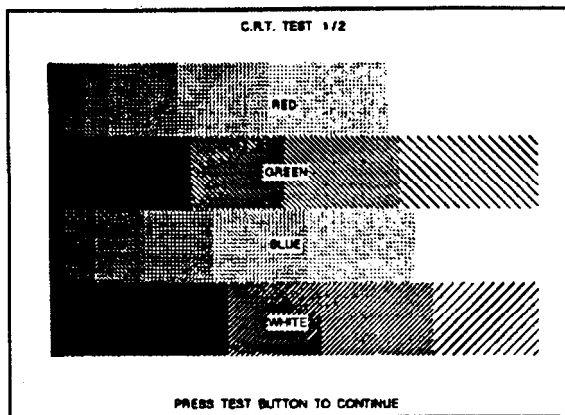

5. C.R.T. Test

In the Test mode menu, selecting C.R.T. Test allows the screen (on which the monitor is tested) to be displayed. Although the monitor adjustments have been made at the time of shipment from the factory, color deviation, etc. may occur due to the effect caused by geomagnetism, the location building's steel frames and other game machines on the periphery. By watching the test mode screen, decide whether an adjustment is needed. If it is necessary, adjust the monitor by referring to the Monitor Adjustments section.

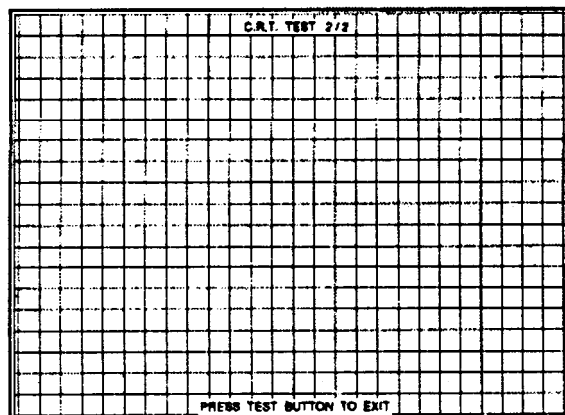

The weight of the machine is approximately 560 lbs. When moving the machine on the floor, be sure to retract the leg adjusters so that the casters make contact with the floor. Attempting to push the machine with leg adjusters extended can cause the machine to fall, causing injury and damage.

EXPLANATION OF TEST AND DATA DISPLAY

By operating the switch unit, periodically perform the tests and data check. When installing the machine initially, or collecting cash, or when the machine does not function properly, perform checks in accordance with this section.

The following test modes should be utilized as applicable.

Items	Description
Installation of Machine	When the machine is installed, perform the following: 1. Check to see that each setting is per standard setting made at the time of shipment. 2. In the INPUT test mode, check each SW and VR. 3. In the OUTPUT test mode, check each of the lamps. 4. In the MEMORY test mode, check the IC's on the PC board.
Memory	Choose MEMORY test in the MENU mode to allow the memory test to be performed. In this test, PROGRAM RAMs, ROMs and IC s on the PC board are checked.
Monthly Servicing	Monthly, perform the following: 1. MEMORY test. 2. Ascertain each setting. 3. In the INPUT test mode, test the CONTROL device. 4. In the OUTPUT test mode, check each of the lamps.
Control System	In the INPUT test mode, check each SW and VR. Adjust or replace each SW or VR. If the problem can not be solved yet, check the CONTROL's moves.
Monitor	In the MONITOR ADJUSTMENT mode, check to see if the MONITOR adjustment is correct.
IC Board	1. MEMORY TEST 2. In the SOUND test mode, check the sound related ROMs.
Data Check	Check such data as game play time and histogram to adjust the difficulty level, etc.

Switch Unit

The tests or data check are performed when initially installing the machine, when collecting cash, or when the machine does not function correctly. The switch unit is used to access the various tests and modes listed below. Refer to the explanations given in this section to perform each type of test.

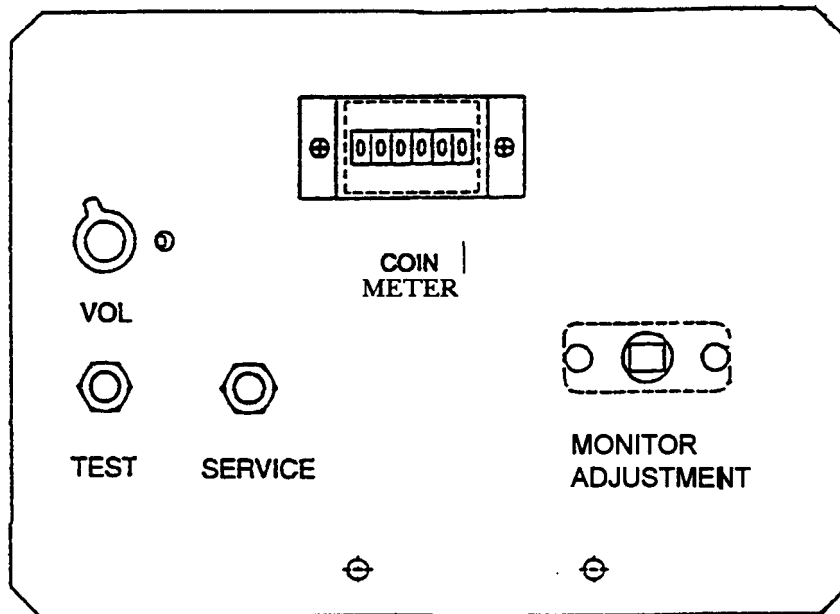

Open the coin chute door, and the switch unit will appear. The functioning of each switch is as follows:

- | | |
|---------------------------|--|
| Test Button | For handling of the Test Button, refer to the following pages. |
| Service Button | Gives credits without registering on the coin meter. |
| Sound Volume | Adjusts the volume of the monitor's right-hand side and left-hand side speakers. |
| Monitor Adjustment | Eliminates color unevenness from the screen. |



WARNING!

Do not touch places other than those specified. Touching places not specified can cause an electric shock or short circuit accident.

Test Mode

The Test Menu allows the functioning of each part of the Cabinet to be checked, the monitor to be adjusted, and the coins and game related various settings to be performed.

- Press the **Test Button** to cause the following Test Menu to be displayed on the monitor.
- Press the **Service Button** until the arrow → is moved to the desired item to make a selection
- Bring the arrow → to the desired item and press the **Test Button** to enter the selected item's test.
- Choosing EXIT and pressing the Test Button will finish the test mode, and the game mode returns on the screen after network checking.

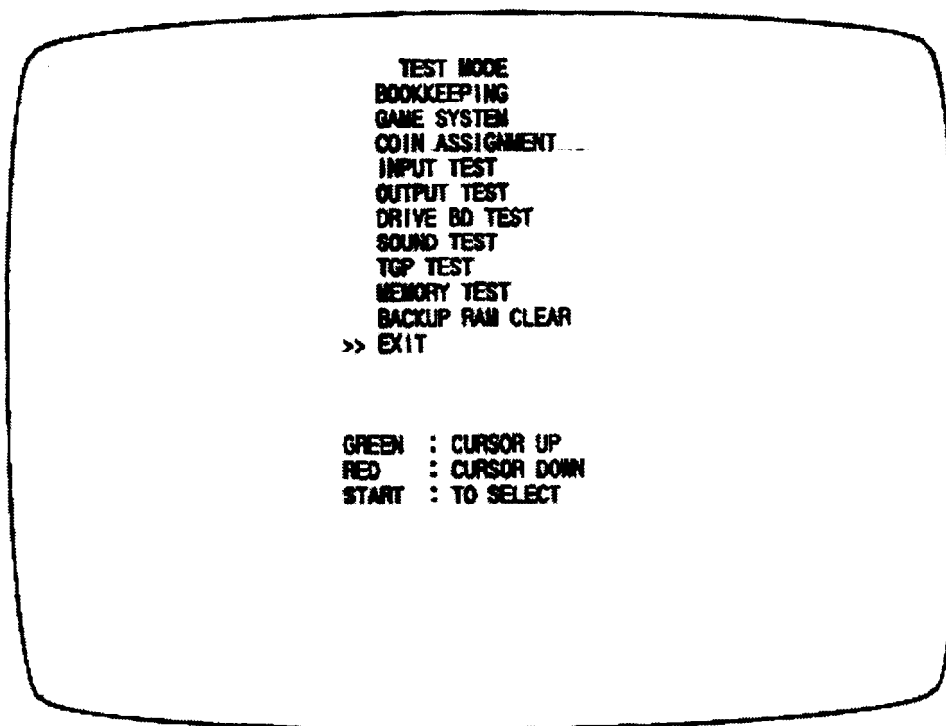

FIG. 8. 2 TEST MENU

When changes are made in the Game Assignments, Coin Assignments and Volume settings, be sure to exit from the test mode to return to game mode. If the power is turned off in test mode, the setting can not be re-written.

BOOKKEEPING

Selecting bookkeeping in the menu mode causes the bookkeeping data up to the present to be displayed.

Press the test button or start button to return to the menu screen.
Press the VR1 red button to proceed to the next page.

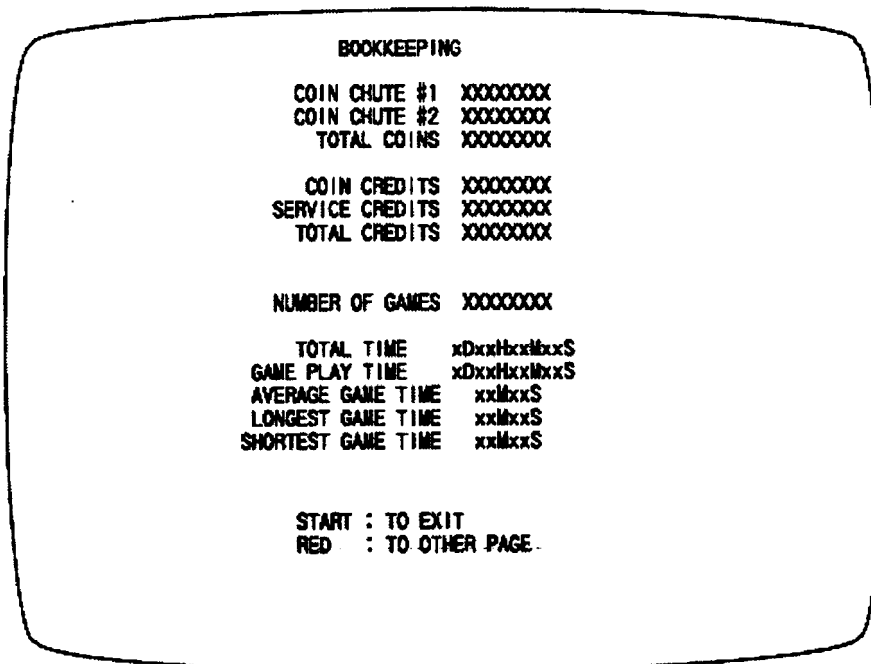

FIG. 8. 3a BOOKKEEPING

COIN CHUTE #	Number of coins put in. As seen from the front of the cabinet, the right hand side is #1 and the left hand side is #2.
TOTAL COINS	Total number of activations of coin chutes.
COIN CREDITS	Number of credits registered by inserting coins.
SERVICE CREDITS	Credits registered by service switch.
TOTAL CREDITS	Total number of credits (coin credits+service credits).
TOTAL TIME	The total energized time.

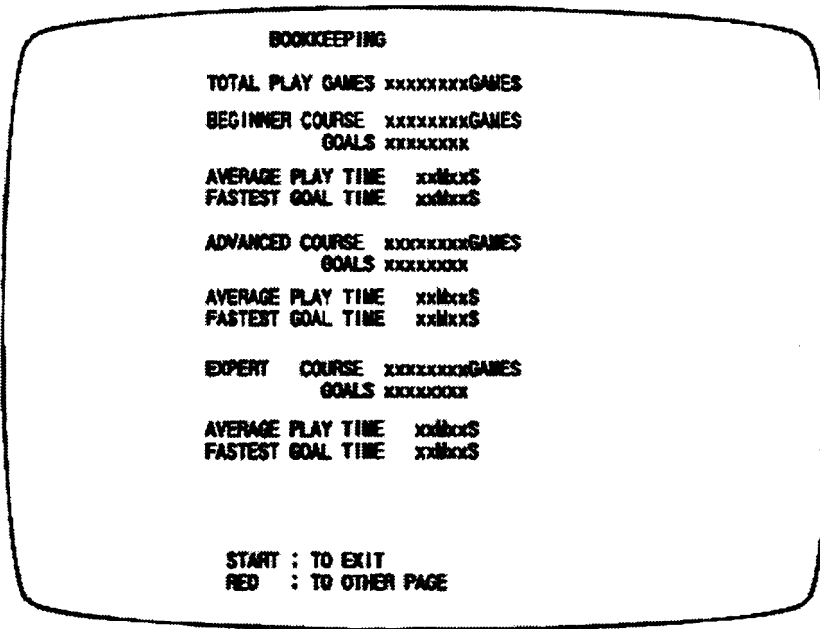

FIG. 8. 3b BOOKKEEPING

BEGINNER COURSE	Beginner course's game play frequency.
ADVANCED COURSE	Advanced course's game play frequency.
EXPERT COURSE	Expert course's game play frequency.
GOALS	Total number of goals each course.

Press the Test SW or Start button to return to the menu mode screen.
 Press VR1 red button to proceed to the other page.

Game System

Selecting the GAME SYSTEM (See Fig. 11) in the menu mode causes the present game settings to be displayed and allows setting changes to be made. Each GAME SYSTEM setting is explained below.

GAME SYSTEM	
LINK ID	SINGLE
CAR NUMBER	1
CABINET	STAND ALONE
COUNTRY	USA
DIFFICULTY	NORMAL
ADVERTISE SOUND	ON
GAME MODE	NORMAL
RIVAL ARROW	ON
>> EXIT	
GREEN	: CURSOR UP
RED	: CURSOR DOWN
YELLOW	: MODE UP
BLUE	: MODE DOWN
START	: TO SELECT

- LINK ID:** Standard setting is "SINGLE". For linked units, set one to "MASTER" and the rest of the seats to "SLAVE". The game setting and coin setting, etc. of the MASTER seat apply to all SLAVE seats. Changes made to SLAVE seats are not effective.
- CAR NUMBER:** For linked play between 2 or more machines, the machines are numbered in sequential order: No. 1, No. 2, No. 3, ... No. 8. Numbering is done starting from the left, facing the monitor screen. If the same number is used for 2 or more cabinets or if cabinets are numbered in an incorrect sequence, the on-screen display may be confused.
- CABINET:** Setting of cabinet type. Set to "STAND ALONE" for this machine.
- COUNTRY:** Message language. Choices are "USA", "EXPORT", and "JPN".
- DIFFICULTY:** The game difficulty is classified into 4 different categories from "EASY" to "HARDEST". The standard setting is "NORMAL".
- ADVERTISE SND:** Set to "OFF" to have machine silent during standby. Standard setting is "OFF."

GAME MODE: Selection of lap count ranges for BEGINNER, ADVANCED, and EXPERT courses. Allows lap count to be changed for specific attraction event purposes. Ranges are: "NORMAL" (8, 4, 2 laps), "GRAND PRIX" (20, 10, 5 laps), and "ENDURANCE" (80, 40, 20 laps).

SETTING CHANGE PROCEDURE

1. Press the SERVICE switch or VR1 (red) OR VR2 (green) to move the arrow (>>) to the desired item.
2. Choose the desired setting change item by using one of: VR2 (blue), VR3 (yellow), the TEST switch, or the START button.
3. To return to the MENU mode, move the arrow to EXIT and press the TEST switch or the START button.

Coin Assignments

This mode permits you to set the start number of credits, as well as the basic numbers of coins and credits. This mode expresses "how many coins correspond to how many credits".

Setting change is not effective until Exiting. Be sure to Press test to Exit after setting change.

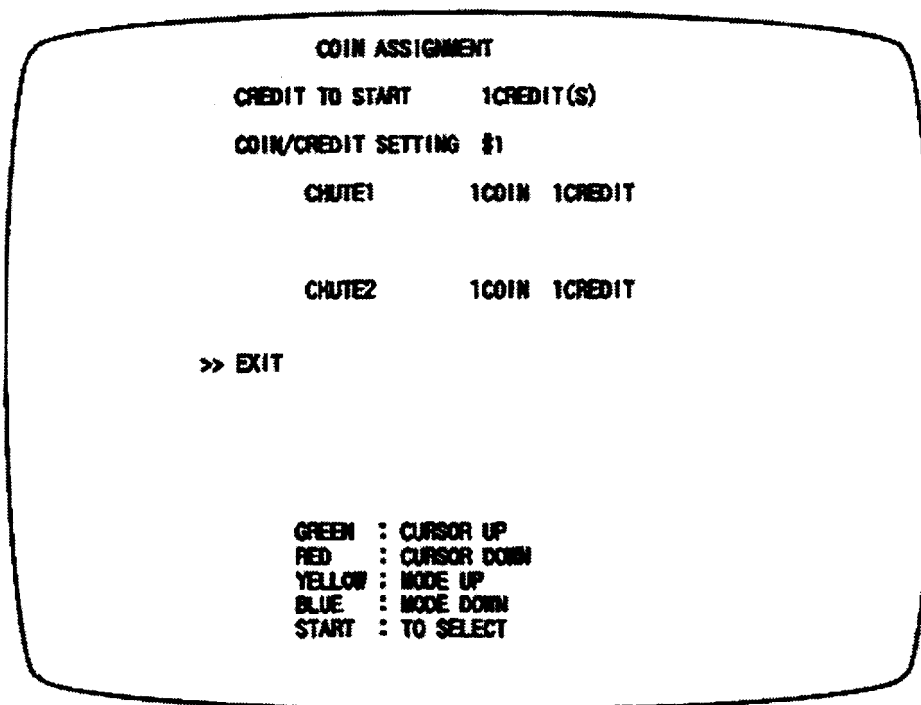

FIG. 8. 5 COIN ASSIGNMENTS

Credit to Start	Sets the number of credits required when starting the game.
Credit to Continue	This sets the number of credits required to continue game.
Coin/Credit Setting	How many coins correspond to how many credits. In this machine, selection as per the adjacent chart is possible.
Manual Setting	Allows for finer settings. See chart.

1. Press the Service button or Shift button to bring the arrow to the desired change item.
2. Press the Test button or the Start button to select the setting change item.
3. Move the arrow to Exit and press the Test button or the Start button to return the menu mode to the screen.

TABLE 8. 10 a COIN/CREDIT SETTING (COIN CHUTE COMMON TYPE)

SETTING	FUNCTIONING COIN CHUTE #1		FUNCTIONING COIN CHUTE #2	
SETTING #1	1 COIN	1 CREDIT	1 COIN	1 CREDIT
SETTING #2	1 COIN	2 CREDITS	1 COIN	1 CREDIT
SETTING #3	1 COIN	3 CREDITS	1 COIN	1 CREDIT
SETTING #4	1 COIN	4 CREDITS	1 COIN	1 CREDIT
SETTING #5	1 COIN	5 CREDITS	1 COIN	1 CREDIT
SETTING #6	1 COIN	2 CREDITS	1 COIN	2 CREDITS
SETTING #7	1 COIN	5 CREDITS	1 COIN	2 CREDITS
SETTING #8	1 COIN	3 CREDITS	1 COIN	3 CREDITS
SETTING #9	1 COIN	4 CREDITS	1 COIN	4 CREDITS
SETTING #10	1 COIN	5 CREDITS	1 COIN	5 CREDITS
SETTING #11	1 COIN	6 CREDITS	1 COIN	6 CREDITS
SETTING #12	2 COINS	1 CREDIT	2 COINS	1 CREDIT
SETTING #13	1 COIN	1 CREDIT	2 COINS	1 CREDIT
SETTING #14	1 COINS	2 CREDITS	2 COINS	1 CREDIT
SETTING #15	1 COIN	1 CREDIT	1 COIN	1 CREDIT
	2 COINS	3 CREDITS	2 COINS	3 CREDITS
SETTING #16	1 COIN	3 CREDITS	1 COIN	1 CREDIT
			2 COINS	3 CREDITS
SETTING #17	3 COINS	1 CREDIT	3 COINS	1 CREDIT
SETTING #18	4 COINS	1 CREDIT	4 COINS	1 CREDIT
SETTING #19	1 COIN	1 CREDIT	1 COIN	1 CREDIT
	2 COINS	2 CREDITS	2 COINS	2 CREDITS
	3 COINS	3 CREDITS	3 COINS	3 CREDITS
	4 COINS	5 CREDITS	4 COINS	5 CREDITS
SETTING #20	1 COIN	5 CREDITS	1 COIN	1 CREDIT
			2 COINS	2 CREDITS
			3 COINS	3 CREDITS
			4 COINS	5 CREDITS
SETTING #21	5 COINS	1 CREDIT	5 COINS	1 CREDIT
SETTING #22	1 COIN	2 CREDITS	3 COINS	1 CREDIT
			5 COINS	2 CREDITS
SETTING #23	2 COINS	1 CREDIT	2 COINS	1 CREDIT
	4 COINS	2 CREDITS	4 COINS	2 CREDITS
	5 COINS	3 CREDITS	5 COINS	3 CREDITS
SETTING #24	1 COIN	3 CREDITS	2 COINS	1 CREDIT
			4 COINS	2 CREDITS
			5 COINS	3 CREDITS
SETTING #25	1 COIN	1 CREDIT	1 COIN	1 CREDIT
	2 COINS	2 CREDITS	2 COINS	2 CREDITS
	3 COINS	3 CREDITS	3 COINS	3 CREDITS
	4 COINS	4 CREDITS	4 COINS	4 CREDITS
	5 COINS	6 CREDITS	5 COINS	6 CREDITS
SETTING #26	1 COIN	6 CREDITS	1 COIN	1 CREDIT
			2 COINS	2 CREDITS
			3 COINS	3 CREDITS
			4 COINS	4 CREDITS
			5 COINS	6 CREDITS
SETTING #27	FREE PLAY		FREE PLAY	

Manufacturers
Recommended
Setting ***

Input Test

When Input Test is selected, the monitor will show the following, allowing you to watch the status of each switch. On this screen, periodically check the status of each switch.

- By pressing each switch, if the display on the right-hand side of the name of each switch changes to ON from OFF, the switch and the wiring connections are satisfactory. When the Controller (Lever) is operated in the direction of the arrow, the right-hand side indication of the Switch name becomes ON.
- To check Coin Chute #1 and Coin Chute #2 Coin Switches, open the Coin Chute Door and insert coin(s) into the slot.
- To return to the Menu mode, press the Test button.

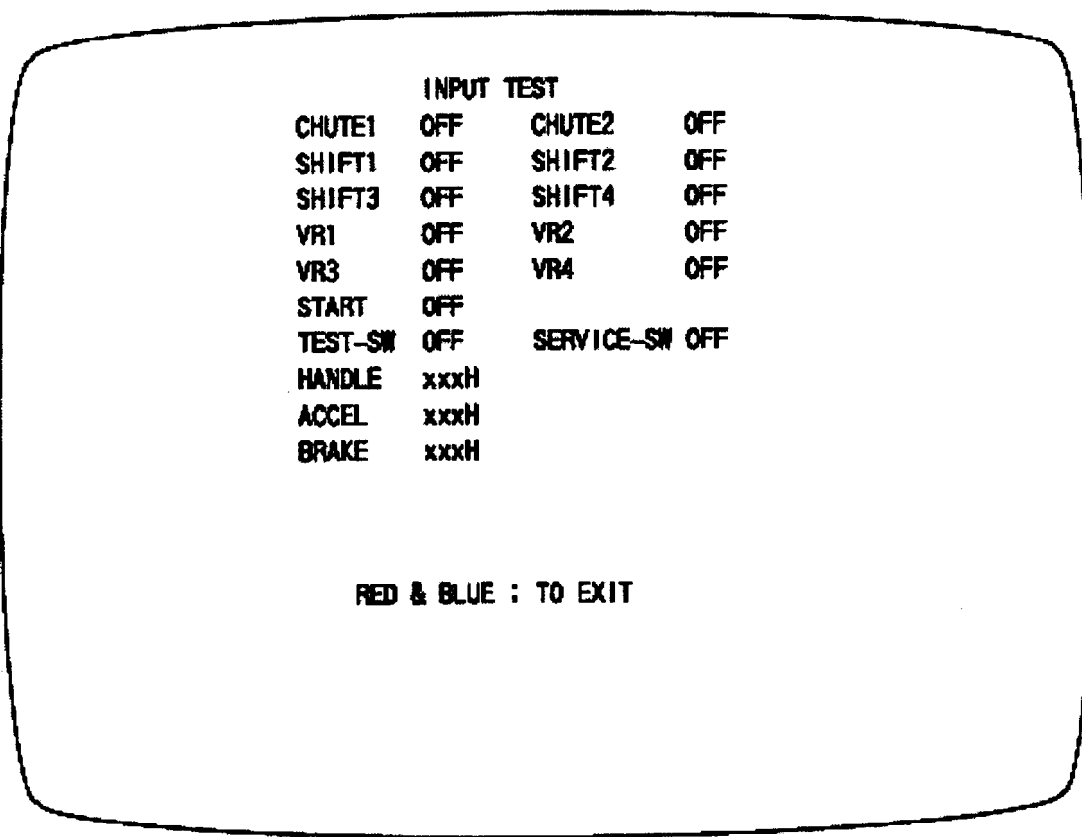

FIG. 8.6 INPUT TEST

Output Test

Selecting Output Test allows the status of each lamp to be viewed. Periodically check the status of each lamp on this screen.

<— Repeatedly displays sequentially in order of start lamp, view change and danger lamp. At this time lamp tests are performed in the manner corresponding to the item displayed.

This game does not have 7-SEG LED. During the display of 7-SEG, only the Start button flashes.

- While this screen is displayed, the Start button continues to flash.
- Press the Test button to return to the menu mode.

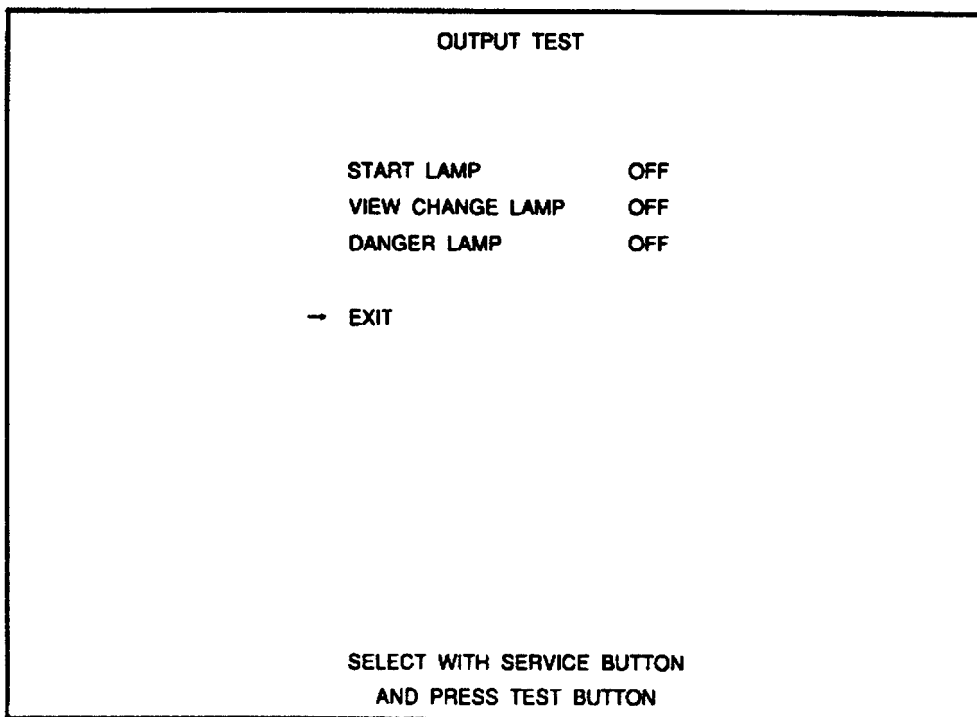

CRT Test

Choose CRT Test to display the screen on which the Monitor adjustment is checked. By watching the screen, periodically check if adjustments are needed or not. For adjustment, refer to the Section of Monitor Adjustment stated herein.

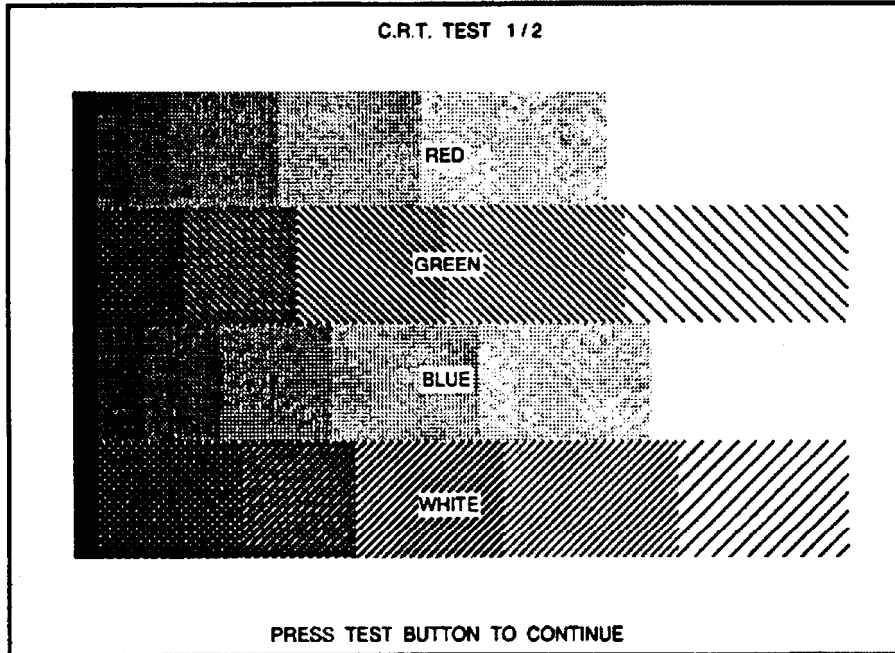

In adjacent figure, check the Monitor's color adjustment. Perform color adjustment by watching this screen.

The color bar of 4 colors, i.e. red, green, blue and white is darkest at the left end and becomes brighter towards the right end.

Pressing the Test button will have the following crosshatch screen appear.

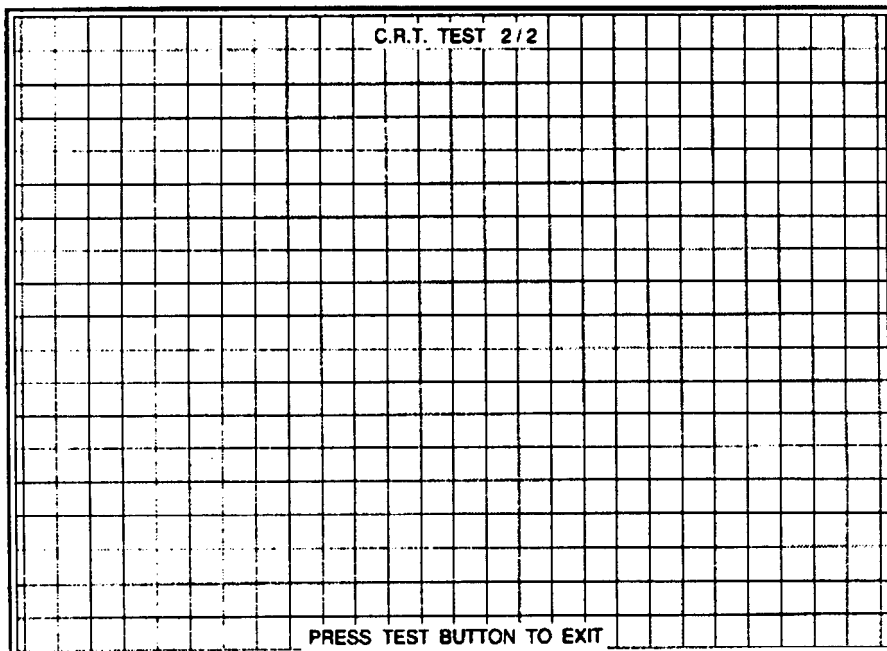

In this figure, check the Monitor size and position adjustment by watching the screen.

Adjust the Monitor in the manner so that the crosshatch lines do not go beyond the screen. Adjust the Monitor to ensure that crosshatch lines do not have distortions.

Press the Test button to return to the menu mode.

DRIVE BOARD TEST

Choosing Drive Board Test allows the reaction mechanism of the steering wheel to be checked. Also, this enables the VR value for the steering wheel's drive board and the settings of the dip switches on the drive board to be checked.

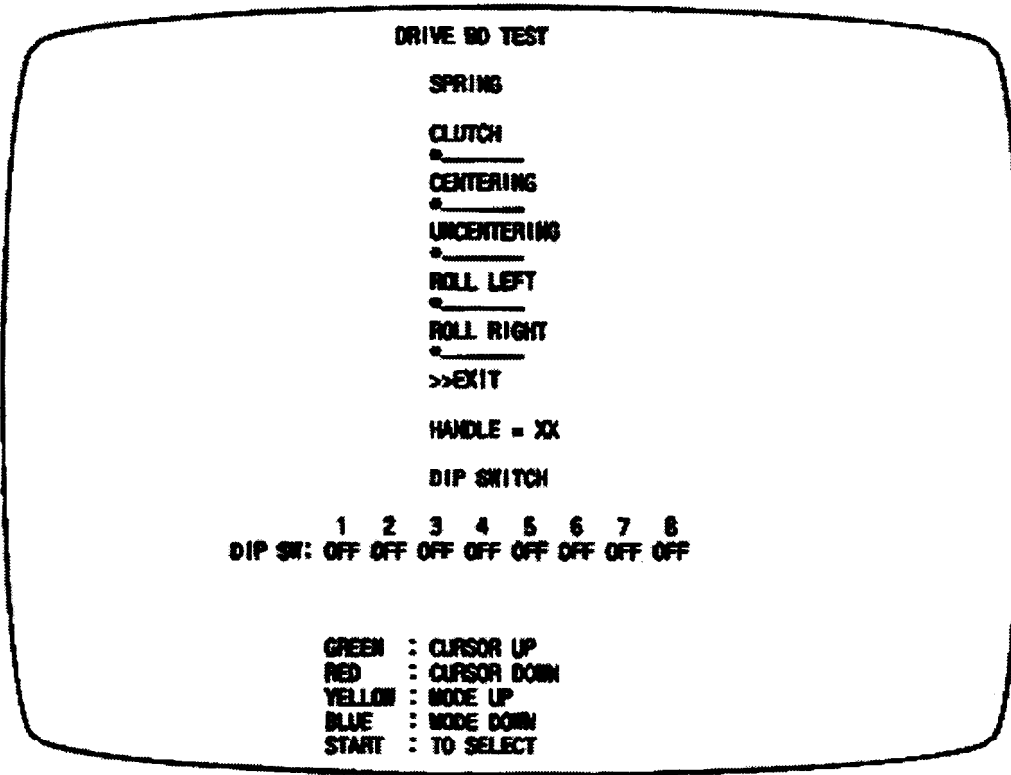

FIG. 8. 8 DRIVE BD TEST

Bring the arrow -> to the desired item by using the service switch or VR1 (red) or VR4 (green). The steering wheel functions to the setting selected by the arrow. Pressing VR2 (blue) or VR3 (yellow) allows the force transmitted to the steering wheel to increase or decrease.

SPRING	Status in which the motor and clutch are not activated. Centering of the handle is caused by only the spring inside the handle mechanism.
CLUTCH	Status in which the clutch is activated. The handle is fixed.
CENTERING	Status in which the handle returns to the center position by itself.
UNCENTERING	Status in which the handle is caused not to be in the center.
ROLL LEFT	Status in which the handle is rotated in the left hand direction.
ROLL RIGHT	Status in which the handle is rotated in the right hand direction.
EXIT	Returns to the menu mode.

Sound Test

Selecting Sound Test allows sounds (sound effects, announcement, background music, etc.) to be chosen and heard. In this mode, check the sound-related IC Board and each speaker. Press the Service button to bring the arrow —> to the desired sound item. Press the Test button to have the selected sound played. Each time the Test button is pressed, the next sound is played.

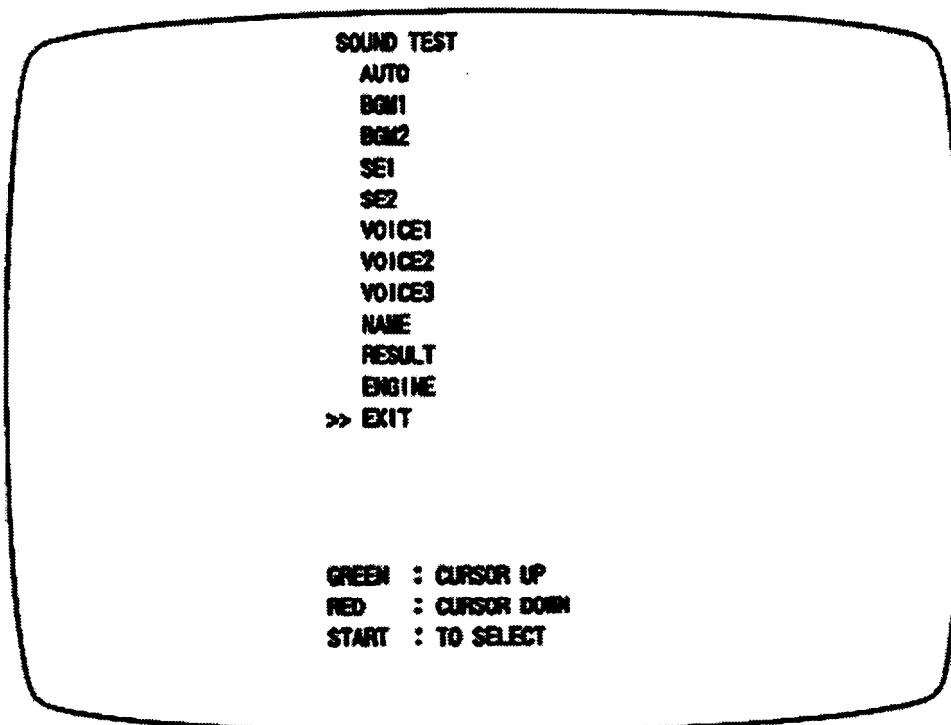

FIG. 8.9 SOUND TEST

TGP TEST

The TGP test allows on-screen related ICs to be checked. As shown, GOOD is displayed for all if satisfactory. Press the test button or start button to return to the menu screen.

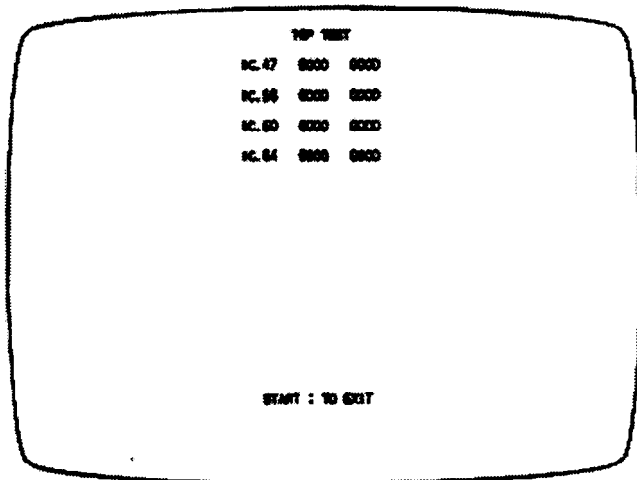

FIG. 8. 10 TGP TEST

MEMORY TEST

The memory test mode is for checking the on-board memory IC functions. GOOD is displayed for normal ICs and BAD for abnormal ICs.

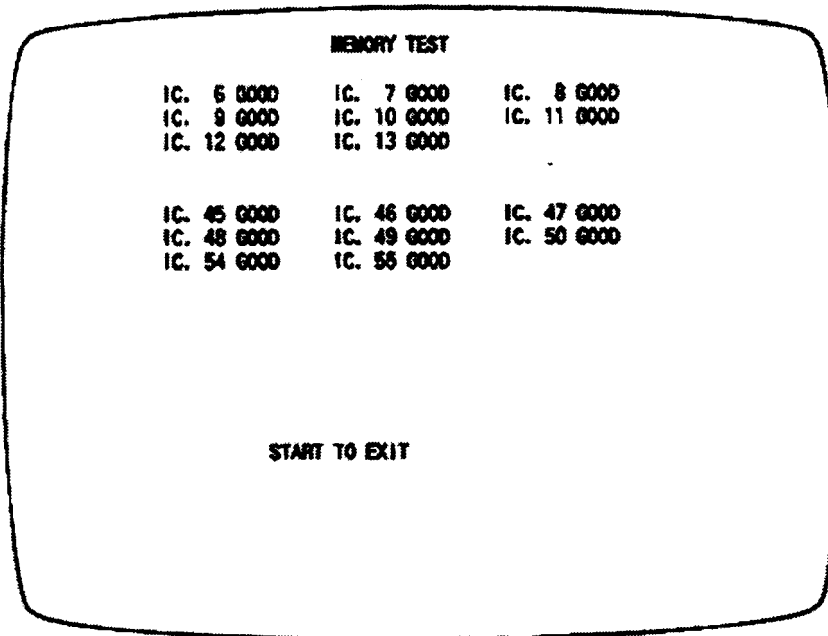

FIG. 8. 11 MEMORY TEST

When the test is completed, if the results are as shown above, testing is satisfactory.

It takes approximately 30 seconds to complete the test. If the period exceeds thirty seconds, there may be a malfunction.

After finishing the test, pressing the test sw or start button allows the menu mode to return to the screen.

BACK UP RAM CLEAR

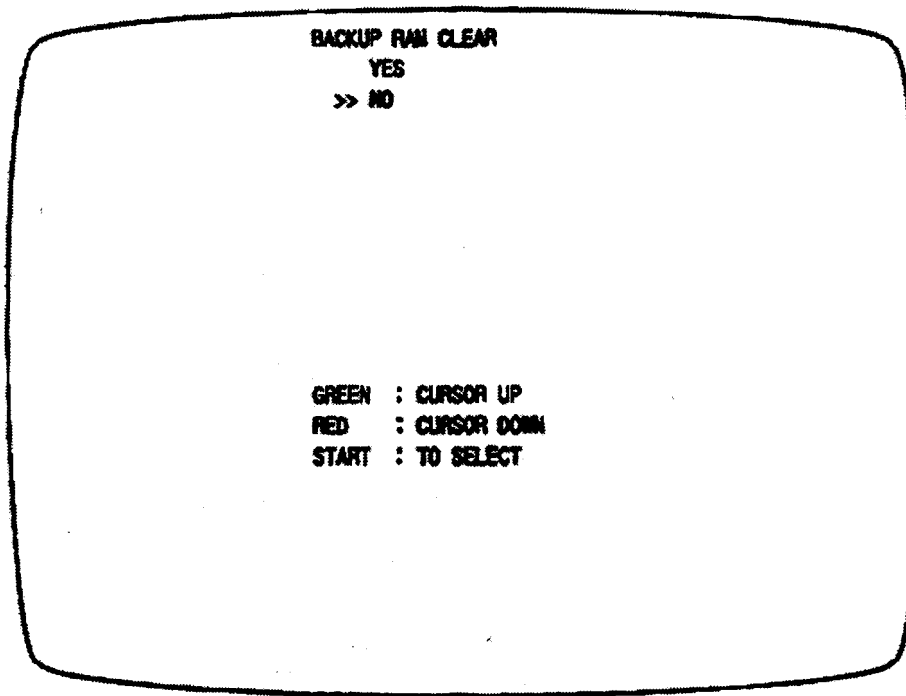

FIG. 8. 12 BACKUP RAM CLEAR

Clears the contents of bookkeeping.

When clearing, bring the arrow --> to YES, when not clearing, to NO by using the service switch or VR1 (red) or VR4 (green) buttons, and then press the test switch or start button.

When the data has been cleared, COMPLETED will be displayed. Bring the arrow back to NO and press the test switch to return to the menu screen.

Also, note that the game setting contents are not affected by the back up clear operation.

HANDLING THE COIN JAM

If the coin is not rejected even when the REJECT button is pressed, open the coin chute door and open the selector gate. After removing the jammed coin, put a normal coin in and check to see that the selector correctly functions.

CLEANING THE COIN SELECTOR

The coin selector should be cleaned once every 3 months. When cleaning, follow the procedure below:

- ① Turn the power for the machine OFF. Open the coin chute door.
- ② Open the gate and dust off by using a soft brush (made of wool, etc.).
- ③ Remove and clean smears by using a soft cloth dipped in water or diluted chemical detergent and then wrung.
- ④ Remove the CRADLE.

When removing the retaining ring (E ring), be very careful so as not to bend the shaft.

- ⑤ Remove stain from the shaft and pillow portions by wiping off with a soft cloth, etc.
- ⑥ After wiping off as per ⑤ above, further apply a dry cloth, etc. to cause the coin selector to dry completely.



- Never apply machine oil, etc. to the Coin Selector.
- After cleaning the Coin Selector, insert a regular coin in the normal working status and ensure that the Selector correctly functions.

COIN INSERTION TEST

Once every month, when performing the Coin SW Test, simultaneously check the following:

- Does the Coin Meter count satisfactorily?
- Does the coin drop into the Cashbox correctly?
- Is the coin rejected when inserted while keeping the Reject Button pressed down?

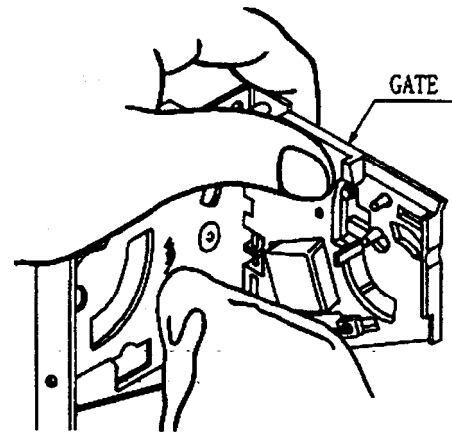

FIG. 10 a

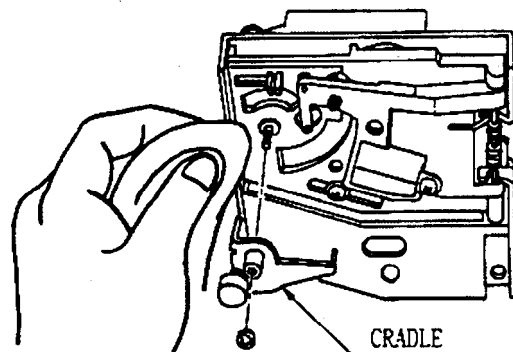

FIG. 10 b

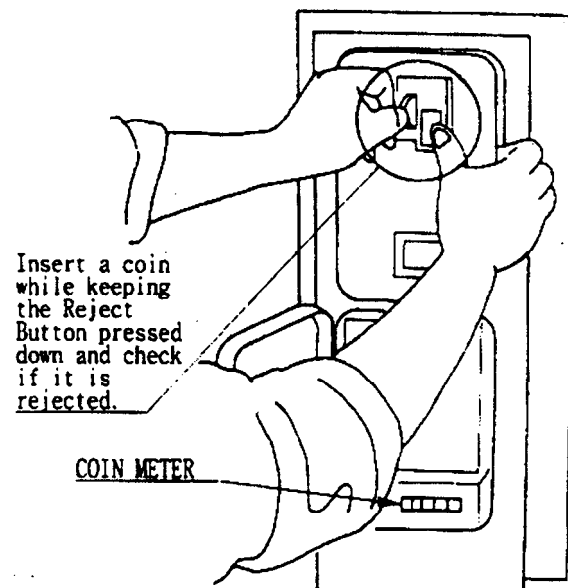

FIG. 10 c

CAUTIONS AND WARNINGS CONCERNING THE SAFETY FOR HANDLING THE MONITORS

Before handling the monitors, be sure to read the following explanations and comply with the caution/warning instructions given below. Note that the caution/warning symbol marks and letters are used in the instructions.



Indicates that handling the monitors erroneously by disregarding this warning may cause a potentially hazardous situation, which could result in death or serious injury.



Indicates that handling the monitors by disregarding this caution may cause a potentially hazardous situation, which could result in personal injury and or material damage.



Indicates that access to a specific part of the equipment is forbidden.



Indicates the instruction to disconnect a power connector or plug.



- When performing such work as installing and removing the monitor, inserting and disconnecting the external connectors to and from monitor interior and the monitor, be sure to disconnect the power connector (plug) before starting the work. Proceeding the work without following this instruction can cause shock or malfunctioning.

- Using the monitor by converting it without obtaining a prior permission is not allowed. SEGA shall not be liable for any malfunctioning and accident caused by said conversion.



● Primary side and Secondary side

The monitor's circuit which is divided into the Primary side and Secondary side, is insulated. Do not touch the primary side, or do not touch both the primary side and the secondary side simultaneously. Not following the instruction can cause shock and this is very dangerous. When making monitor adjustments, use a non-conductive driver and make adjustment without touching any part other than the Adjustment V. R. and knob. Also, be sure not to cause a short-circuit to the Primary side and Secondary side. If short-circuited, it may cause shock or malfunctioning, which is very dangerous.

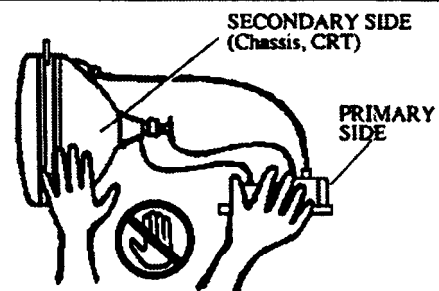

● High-tension Voltage

Some of the parts inside monitor are subject to high-tension voltage in excess of 20,000 volts and very dangerous. Therefore, be sure not to touch the monitor interior. Should soldering & paper wastes, etc. be mixed in the monitor interior, turn the power off so as not to cause malfunctioning or fire hazard.

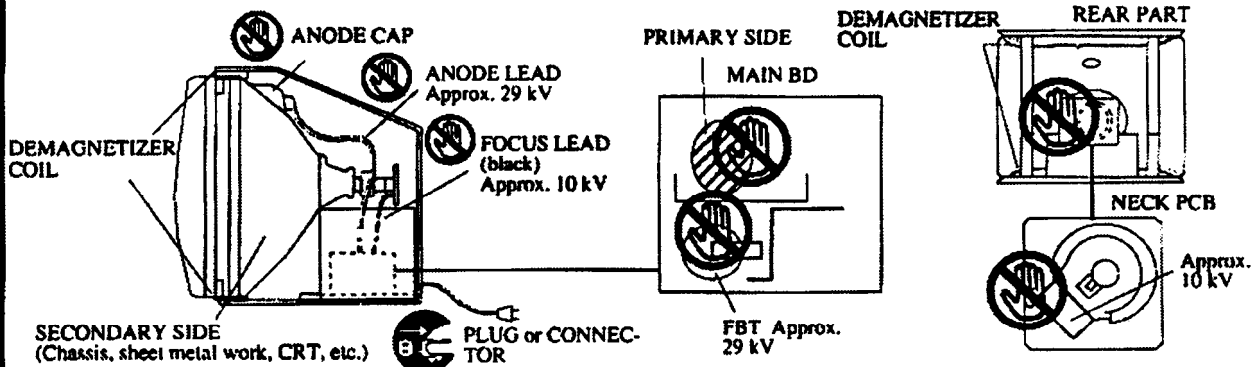

● Connecting the CRT and PCB

For combining the CRT and PCB, use the specified part No. to maintain the status of adjustments made at the factory. The anode of the CRT itself will be accumulatively charged as time elapses, generating high-tension voltage which is very dangerous. The monitor should be used with the Chassis, CRT and PCB assembled. When repair, etc. is required at the time of malfunctioning, be sure to send it in an "as is assembled" condition. If these are disassembled, what's charged to said high tension voltage can be discharged, causing a very hazardous situation. Therefore, under no circumstances should it be disassembled.

● Static Electricity

Touching the CRT surface sometimes causes you to slightly feel electricity. This is because the CRT surfaces are subject to static and will not adversely affect the human body.

● Installation and removal

Ensure that the Magnetizer Coil, FBT (Fly-Back Transformer), Anode Lead and Focus Lead are not positioned close to the sheet metal work's sharp edges, etc. and avoid damaging the insulated portions so as not to cause shock and malfunctioning. (For the name of parts, refer to the above Figures).

PERIODIC INSPECTION TABLE

The items below require periodic check and maintenance to retain the performance of this machine and ensure safe business operation.

Be sure to clean the interior of the cabinet and inspect and clean the power supply plug once per year. Using the cabinet with dust accumulated can cause a malfunction or fire. Note that careless cleaning work can cause an accident and therefore, proper attention must be paid to ensure continued safe operation of this product.

ITEMS	DESCRIPTION	PERIOD
Controller	Lamp Check	Monthly
	VR Value Check	Monthly
	Greasing	Quarterly
Coin Chute Tower	Check coin switches	Monthly
	Coin Insertion Test	Monthly
	Coin Selector Cleaning	Quarterly
Monitor	Check Adjustments	Monthly
Seat	Antistatic Measures	BiMonthly
Game Board	Memory Test	Monthly
	Setting Check	Monthly
Interior	Cleaning	Annually
Power Plug	Inspection and Cleaning	Annually

TROUBLESHOOTING

The items listed below will assist in troubleshooting when a problem occurs. As a first step, check all wiring connector connections and verify AC power to the machine.

TROUBLESHOOTING

PROBLEM	CAUSE	COUNTER MEASURE
When the main SW is turned ON, the machine is not activated.	The cord is not plugged in. Incorrect power source/voltage. Primary or secondary fuse blown.	Firmly insert the plug into the outlet. Make sure that the power supply voltages are correct. First, remove the cause of overcurrent, then replace the fuse.
MONITOR screen is blackened and the fluorescent lamp does not light up.	Primary or secondary fuse blown.	First, remove the cause of overcurrent, then replace the fuse.
MONITOR screen is all blue.	Defective connections between boards.	Make sure of correct connections between boards.
The color of image on MONITOR screen is incorrect.	Incorrect monitor adjustment.	Make appropriate adjustments.
The on-screen image of the monitor sways or shrinks.	The power source and voltage are not correct.	Make sure that the power supply voltages are correct.
Marquee lamp doesn't light up.	Fluorescent lamp needs replacement. The connector is disconnected. Primary fuse is blown.	Replace lamp. Check connector connections in the marquee. Replace fuse.
Sound is not emitted.	Sound volume adjustment is not correct. Malfunctioning of sound board and/or memory. Connector connection is incorrect.	Adjust the service panel volume control knob. Perform the <i>SOUND TEST</i> . Check connection from base to speaker.
Machine Gun and Missile firing operation is not satisfactory.	SW Malfunction.	SW replacement. Gun trigger part no. 509-5457 Missile Trigger part no. 509-5458
Game makes sounds, but has no picture.	Secondary fuse blown.	Replace the secondary fuse.

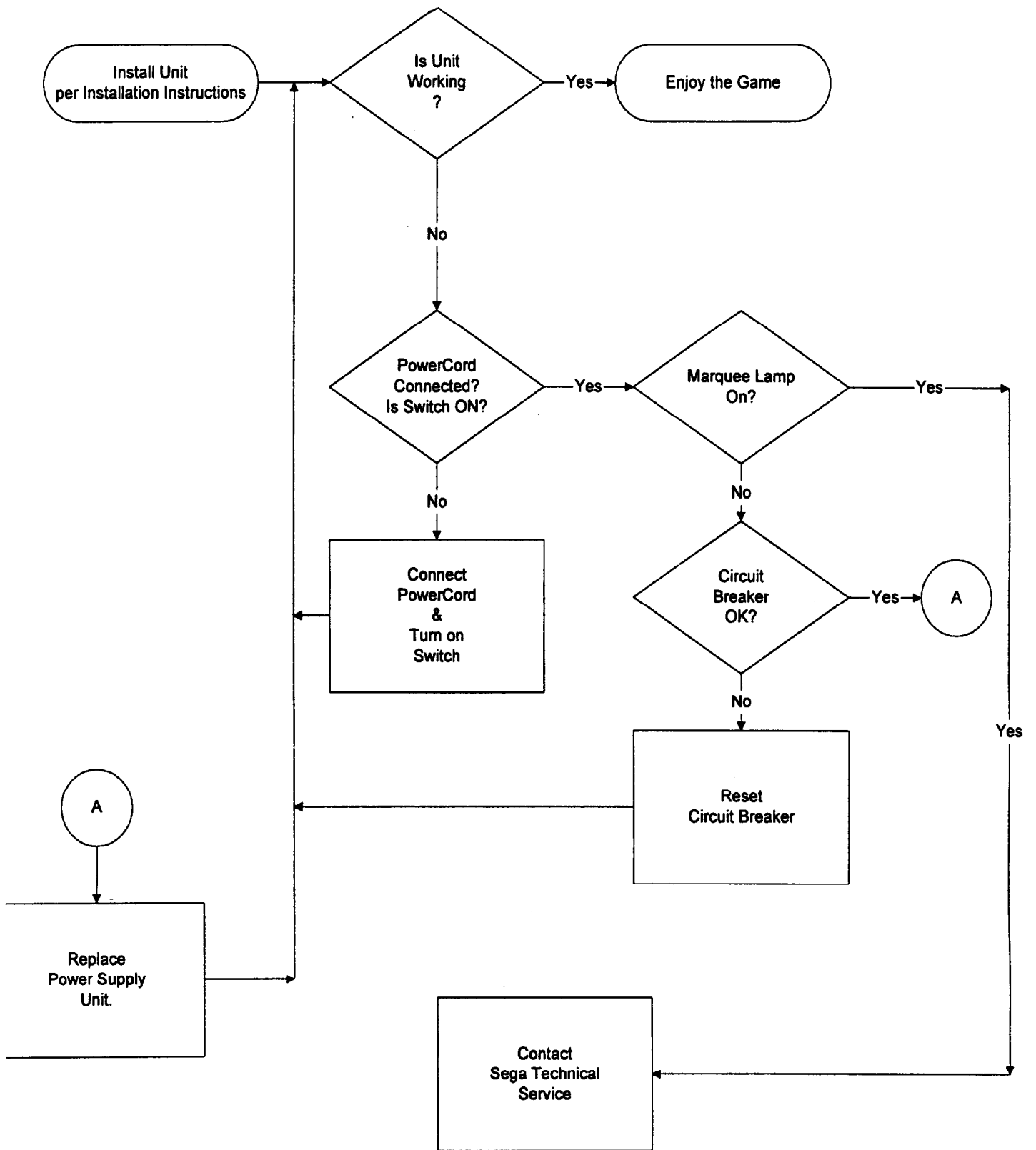

TROUBLESHOOTING CHART



- In order to prevent an electric shock, be sure to turn off power before performing work by touching the interior parts of the product.
- Be careful so as not to damage the wiring. Damaged wiring can cause an electric shock or short circuit accident.



Do not expose the game board, etc, without a good reason. In this product, setting changes are made during the test mode. The game board need not be operated. Use the game board etc, as is with the settings made at the time of shipment.



FOR SERVICE PERSONNEL ONLY!!

REMOVING THE GAME BOARD

To replace the IC boards, such as the game board, drive board, etc., or to change the dip switch settings, take out the IC board using the following procedure.

Turn the main switch off.

At the rear of the unit, find the rear access door.

Remove the 2 tamperproof screws with the wrench provided.

Open the rear door using the back door key.

Take off the 3 screws to remove the case lid. The game board is contained in the shield case.

SCREW (4)
M3×35, using flat &
spring washers

SCREW (7)
M3×75, using flat &
spring washers

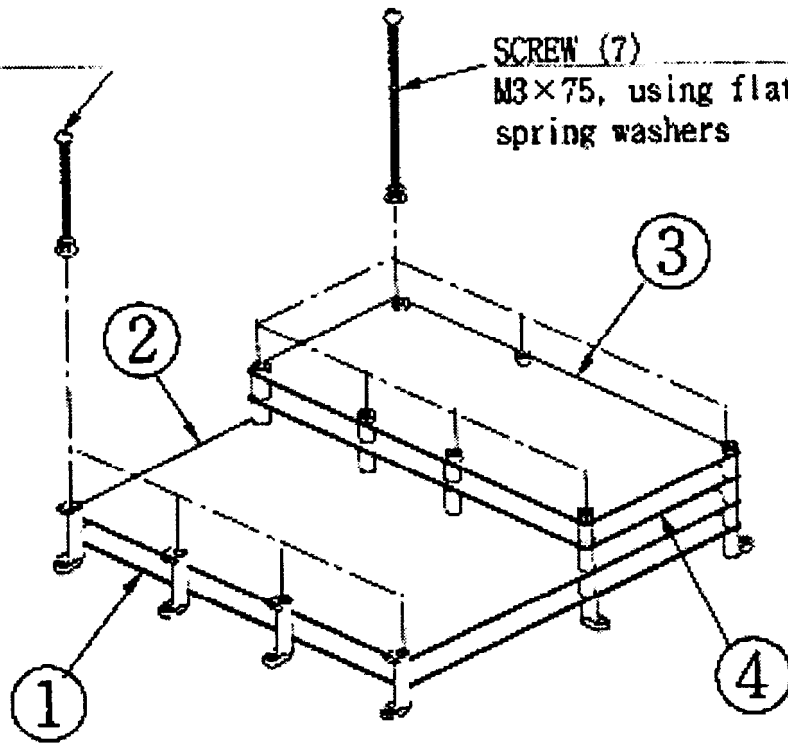

GAME BOARD SERVICE RECORD

This page is provided for your use in tracking repairs or replacements of your Sega game PCBs and assemblies. This information can help provide a service history for your game should it ever be sold or transferred.

DATE **BOARD ASSY NO.** **PCB SERIAL NO.** **RMA NO.**

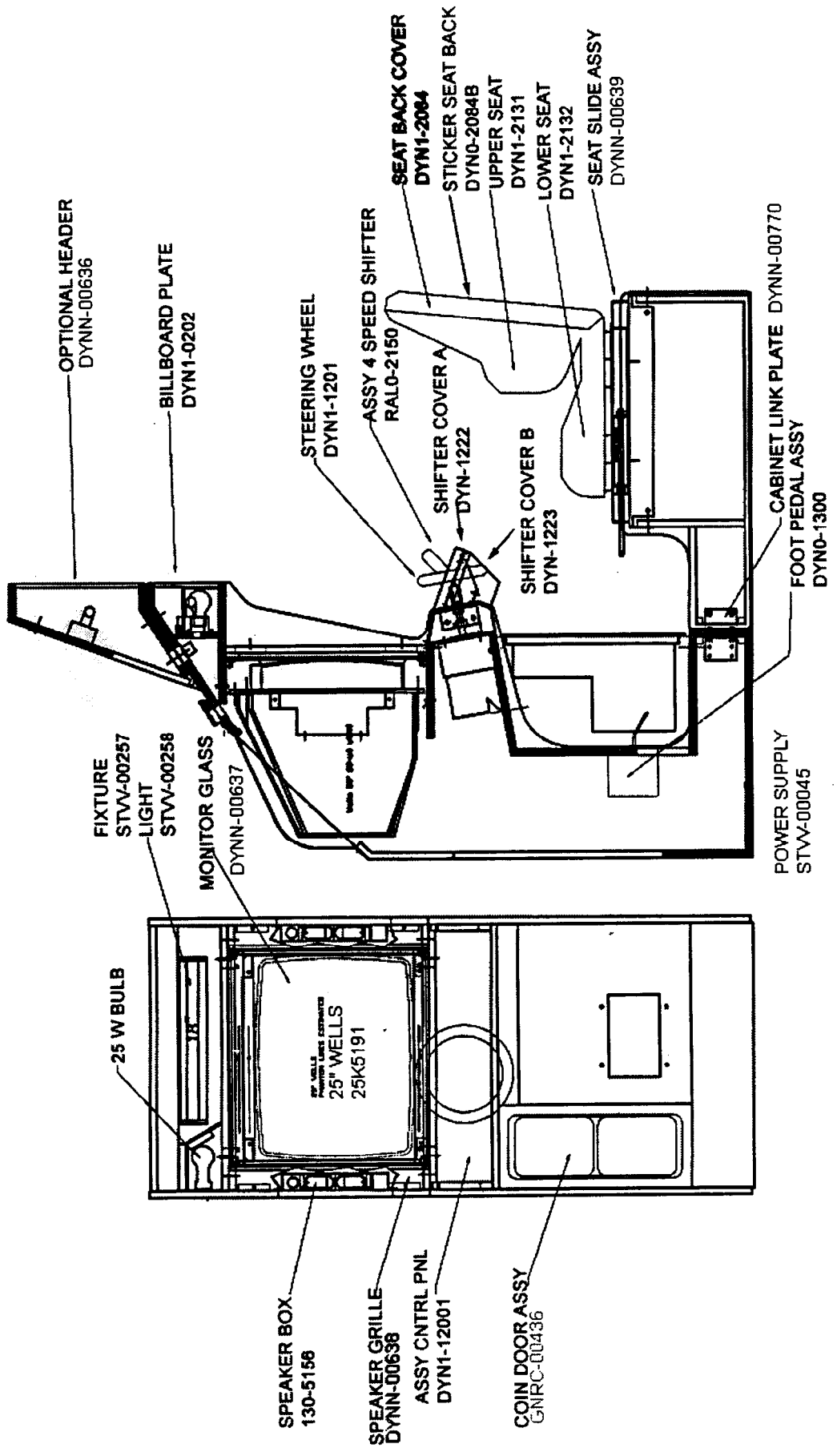

ASSY VIRTUAL BUTTON
DYN0-1290

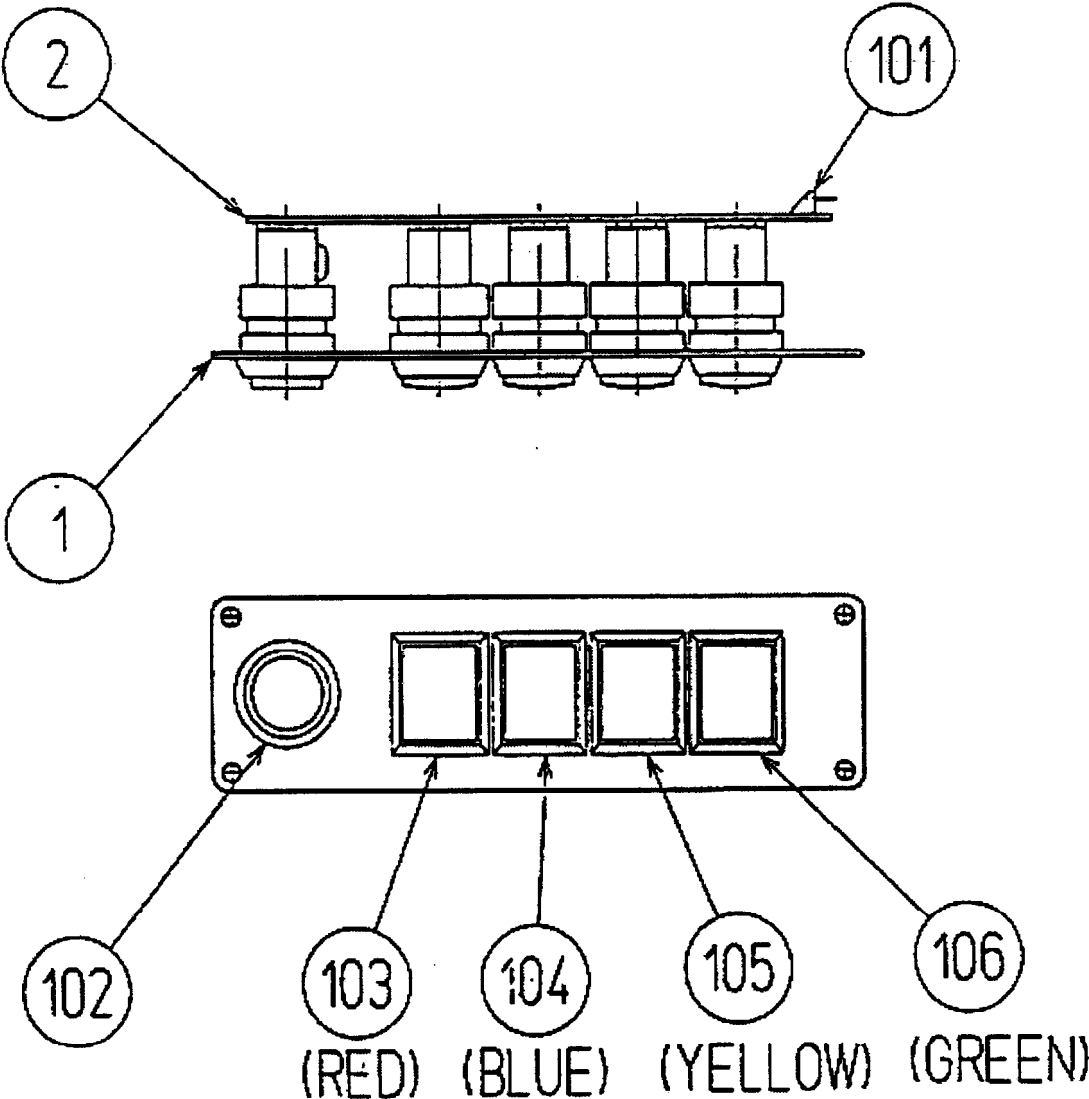

ASSY SPEAKER
130-5156

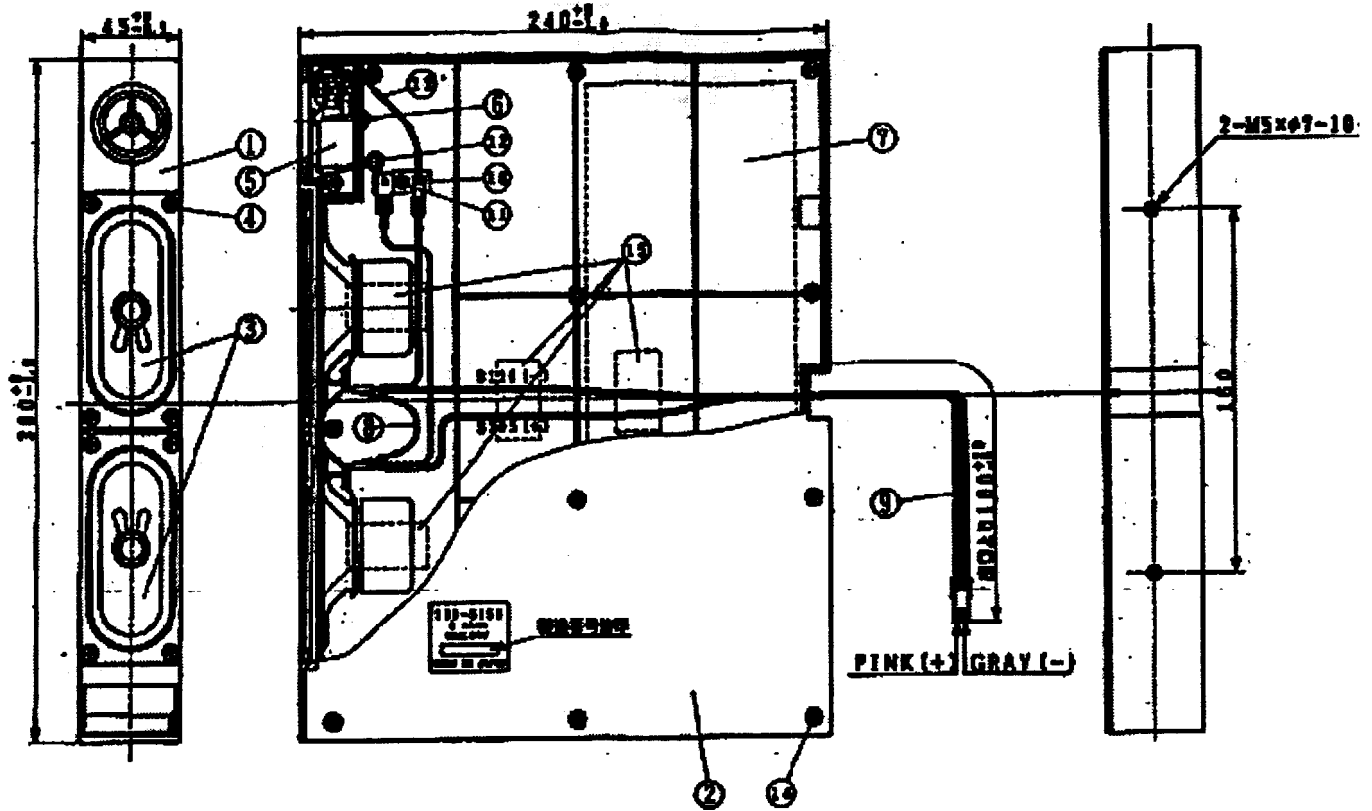

ITEM	PART NUMBER	DESCRIPTION	NOTE
1	DYN-1251	HANDLE BASE	
2	DYN-1252	BASE LID	
3	DYN-1253	HANDLE SHAFT	
4	DYN-124	DRIVE PULLEY	
5	DYN-1255	HANDLE PULLEY	
6	DYN-1256	CLUTCH PULLEY A	
7	DYN-1257	CLUTCH PULLEY B	
8	DYN-1258	MOTOR BRACKET	
9	DYN-1259	CLUTCH BRACKET	
10	DYN-1260	TENSIONER BRACKET	
11	DYN-1261	VR BRACKET	
12	DYN-1262	SWING ARM SHAFT	
13	DYN-1263	GUIDE HOLDER A	
14	DYN-1264	GUIDE HOLDER B	
15	DYN-1265	STOPPER RUBBER	
16	DYN-1266	STOPPER BOLT	
17	DYN-1267	HOUSING	
18	DYN-1268	SPRING HOOK	
19	DYN-1269	EXT SPRING	
20	DYN-1270	STOPPER KEY	
21	DYN-1272	SPACER RING	
22	DYN-1273	SWING ARM	
23	BVG-1221	GEAR HOLDER	
24	BVG-1340	FLT WSHR 8.1-12X2	
25	BVG-1341	FLT WSHR 4.1-12X2	
26	SLC-1130	ADJUST RING	
27	SLC-1141X	WHITE CAM	
28	SOR-2112	BEARING SHAFT	
29	SOR-2113	SPACER	
30	SOR-2115	KEY 5X10	
31	DYN-1274	GUARD BRKT	
101	100-5018	BALL BEARING Ø 8 (NSK 608ZZ)	
102	100-5112	BEARING Ø 17 (NSK 6003ZZ)	
103	100-5041	BEARING (NSK F688ZZ)	
104	220-5373	VOL CONT B-5K OHM	
104	220-5484	VOL CONT B-5K OHM	
105	350-5235	MOTOR AC100V 1250/1550rpm W/H	
105	350-5294	MOTOR AC100V 60W	
106	601-6172	GEAR 48	
107	601-6959	GEAR 64	
108	601-7487	TIMING BELT (150 5M 550)	
109	601-7488	TIMING BELT (100 5M 750)	
110	601-7489	PARTICLE CLUTCH BRAKE	
111	310-5029-F20	SUMITUBE F F20MM	
112	601-0460	PLASTIC TIE BELT 10mm	
114	209-0023	CONN CLOSED END	SMALL TYPE
201	020-000410-HZ	HEX SKT CAP SCR BLK OZ M4X10	
202	020-000512-HZ	HEX XKT CAP SCR BLK OZ M5X12	
203	060-S00400	SPR WSHR M4	
204	060-S00500	SPR WSHR M5	

ASSY HANDLE MECHA (DYN-1250)

ITEM	PART NUMBER	DESCRIPTION	NOTE
207	000-P00408-W	M SCR PH W/FS M4X8	
208	000P00412-W	M SCR PH W/FS M4X12	
209	000-P00416-S	M SCR PH W/S M4X16	
210	000-P00508-W	M SCR PH W/FS M5X8	
211	060-F00600	FLT WSHR M6	
212	060-F00800	FLT WSHR M8	
213	065-E00700	E RING 7MM	
214	068-441616	FLT WSHR 4.4-16X1.6	
215	028-A00308-P	SET SCR HEX SKT CUP P M3X8	
216	028-A00408-P	SET SCR HEX SKT CUP P M4X8	
217	050-U00500	U NUT M5	
218	050-H00600	HEX NUT M6	
219	050-U00800	U NUT M8	
220	000-P00408-S	M SCR PH W/S M4X8	
221	000-P00310	M SCR PH M3X10	
222	060-F00300	FLT WSHR M3	
223	060S00300	SPR WSHR M3	
225	050-U00600	U NUT M6	

ASSY ACCEL & BRAKE (DYN-1300)

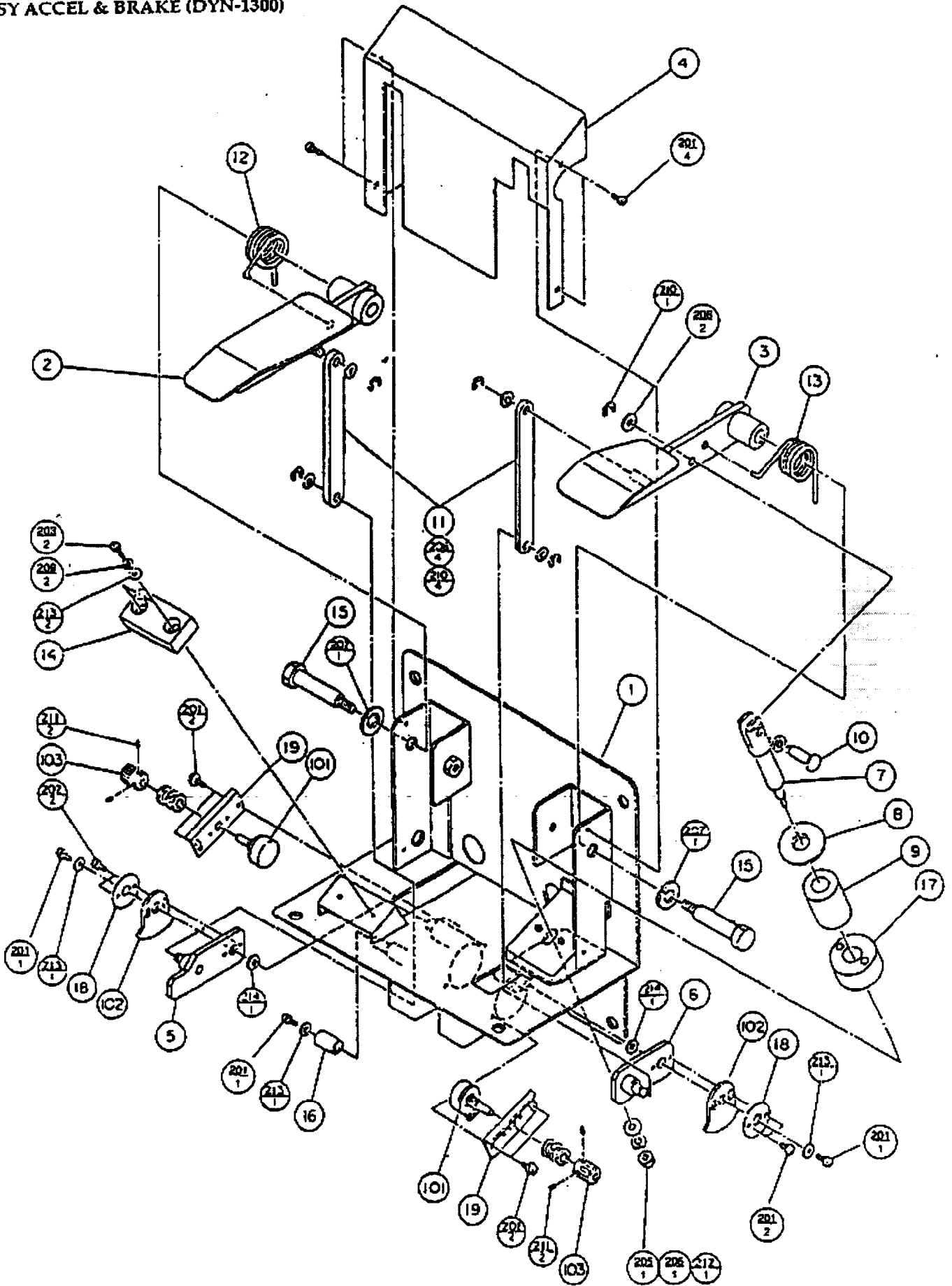

ITEM	PART NUMBER	DESCRIPTION	NOTE
1	DYN1-1301	PEDAL BASE	
2	BVG-1402	ACCEL PEDAL	
3	BVG-1403	BRAKE PEDAL	
4	BVG-1404	PEDAL COVER	
5	BVG4-1405	SWING ARM A	
6	BVG4-1406	SWING ARM B	
7	BVG-1407	PUSH ROD	
8	BVG-1408	PUSH PLATE	
9	BVG-1418	RUBBER DUMPER	
10	BVG-1410	PUSH ROD PIN	
11	BVG-1411	LINK ROD	
12	BVG-1412	TORSION SPRING ACCEL	
13	BVG-1413	TORSION SPRING B	
14	BVG-1414	RUBBER STOPPER	
15	BVG1-1415	PEDAL SHAFT	
16	BVG-1416	SWING ARM STOPPER	
17	BVG-1417	SPACER	
18	GLC-2122	GEAR PLATE	
19	RDM-1210	VR BRACKET	
101	220-5373	VOL CONT B-5K OHM	
102	601-6005	ADJUST GEAR	
103	601-5943	GEAR 20 Ø 15	
201		SCREW MS ZN 08-32X06 PH PN	
203		SCREW MS BO 08-32X12 PH PN	
205		NUT HEX M6	
206		WASHER FL BO 11/16 X 11/32 X 3/32	
207		WASHER SPLIT LOCK 13/16 X 1/2 X 3/32	
208		WASHER SPLIT LOCK 1/4	
209		WASHER SPLIT LOCK #8	
210		RING "E" 05133-25	
211		SCREW SET 30 M3X06MM	
212		WASHER FL 80 1/2 X 7/32 X 1/16	
213		WASHER FL 30 #8	
214	DYN-1305	FLT WSHR 12.2-22 X 0.5	
215		RING "E" 05133-18	

ADDITIONAL PARTS

833-10651	GAME BOARD DAYTONA TWIN
837-10539	IO BOARD DAYTONA
837-10652	SOUND BOARD DAYTONA TWIN
839-0683	FILTER BOARD MODEL 2 MAIN TWIN
839-0657	FILTER BOARD DAYTONA IO A
839-0658	FILTER BOARD DAYTONA IO B
838-10018	AMP BOARD SERVO
839-0542	AUDIO MIX BOARD
DYN-1222	SHIFT COVER A
DYN-1223	SHIFT COVER B
601-7489	PARTICLE CLUTCH BRAKE
350-5235	MOTOR AC 100V 1250/1550RPM W/H
600-6275-0300	ASSY CABLE o5 0300CM
600-6275-0500	ASSY CABLE o5 0500CM
211-5479	CONN OPT JOINT
000-T00412-0C	M SCR TH CRM M4X12
068-441616-0C	FLT WSHR CRM 4.4-16X1.6
100-5170	BEARING
100-5188	DERURING BEARING
130-5156	SPEAKER BOX 8 OHM 20 WATT
838-10646	DRIVE BD DAYTONA TWIN

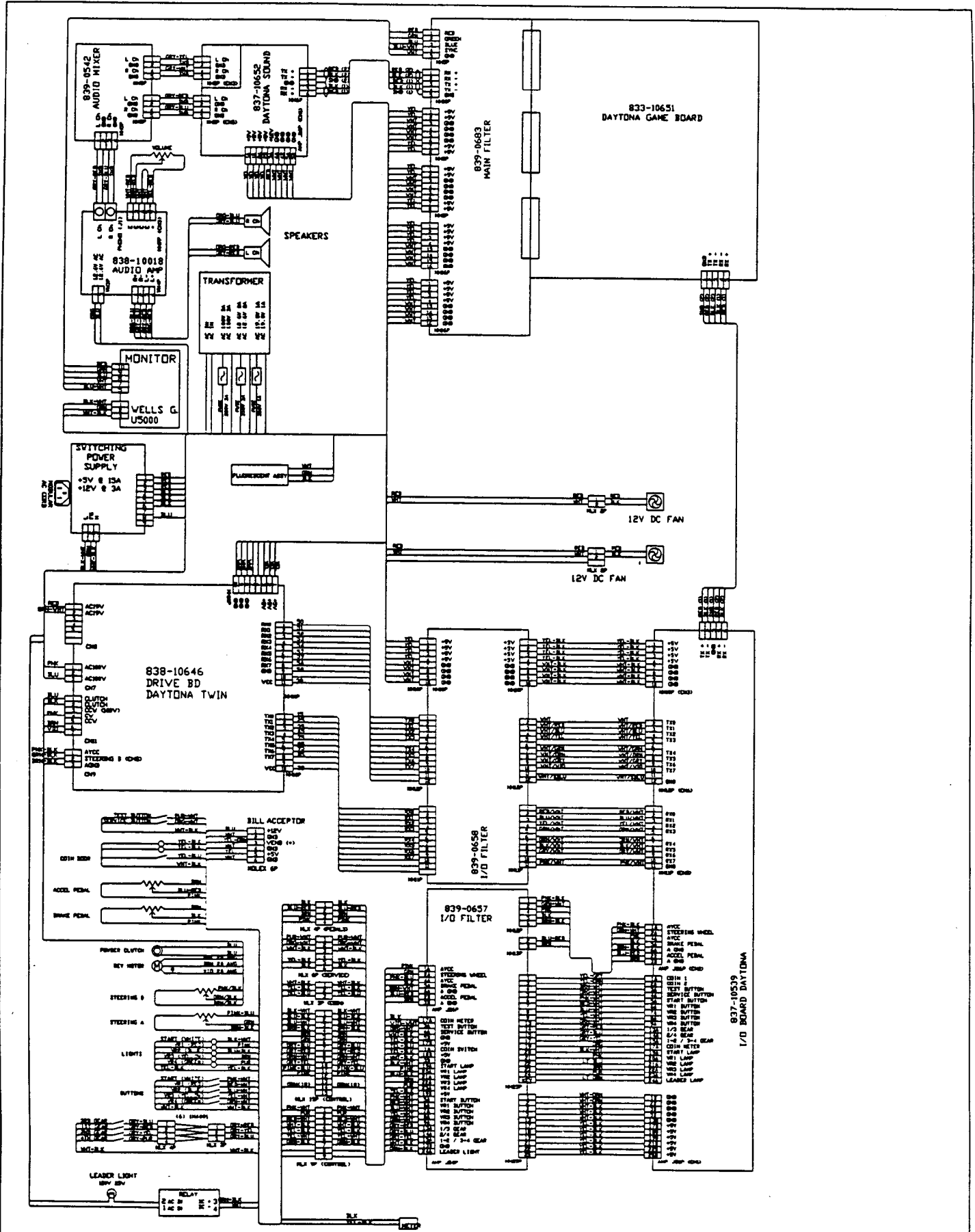



SEGA ENTERPRISES, INC. (USA)

45133 Industrial Drive

Fremont, CA 94538

415-802-1750 phone

415-802-1754 fax