

Dark Stalkers™

MANUAL

WARNING

This game is for use in the United States of America and Canada. Sales, export or operation outside of these countries may be construed as copyright and trademark infringements and is strictly prohibited. Violators are subject to severe penalties and will be prosecuted to the full extent of the law.

WARNING

THIS GAME MUST BE GROUNDED. FAILURE TO DO SO MAY RESULT IN DESTRUCTION TO ELECTRONIC COMPONENTS.

WARNING: This equipment generates, uses and can radiate radio frequency energy and if not used in accordance with the instruction manual, may cause interference to radio communication. It has been tested and found to comply with the limits for a CLASS A computing device pursuant to SUBPART J and PART 15 of FCC RULES, which are designed to provide reasonable protection against such interference when operated in a commercial environment. Operation of this equipment in a residential area is likely to cause interference in which case the user at his own expense will be required to take whatever measures may be required to correct the interference.



"WINNERS DON'T USE DRUGS"

Louis Freeh, Director, FBI

• IN COOPERATION WITH THE AAMA AND FBI ANTI-DRUG CAMPAIGN •

CAPCOM

INVITES YOU TO USE

OUR SERVICE NUMBER FOR
SERVICE INFORMATION CONCERNING THIS GAME, OR ANY
OTHER CAPCOM GAME YOU NOW HAVE ON LOCATION.
PLEASE HAVE GAME SERIAL NUMBERS AND CABINET NUMBERS READY.

**CALL US FOR PROMPT, COURTEOUS
ANSWERS TO YOUR PROBLEMS.**

DIRECT NUMBER 1-800-833-0190

CAUTION

Please keep the following instructions to keep the PC board in good condition

- Do not block the ventilation slots.
- Do not drop or bump the board.
- Do not spill any liquids on the case.
- Do not disassemble the case.

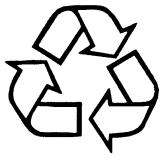

Ni-cd

ATTENTION

The product that you have purchased contains a rechargeable battery. The battery is recyclable. At the end of its useful life, under various state and local laws, it may be illegal to dispose of this battery into the municipal waste system. Check with your local solid waste official for details in your area for recycling options or proper disposal.

DISASSEMBLING THE CASE OR REMOVING THE STICKER MAY CAUSE THE TERMINATION OF YOUR REPAIR WARRANTY.

PARTS LIST

There are two different kits available for Darkstalker. The first kit below is the full kit which includes PCB, all necessary graphics, buttons, joysticks and a volume/test bracket. This kit is used for a cabinet that will be upgraded with the CPS II board for the first time. The second kit is called the "B" Kit. This kit is for any that already uses the CPS II board (Super Street Fighter II). This kit includes the "B" board, all necessary graphics and volume/test bracket. You just remove the top cartridge off the motherboard and replace with the new cartridge.

DK1000

Darkstalker Kit

Part No.	Description	Qty.
DK1400	Darkstalker PCB	1
06-0074	Blue Overlay	1
06-0095	Darkstalker Marquee	1
GE1200	Monitor Card	1
16-0130	1 Player Button	1
16-0131	2 Player Button	1
16-0133	Red Button	4
16-0136	Green Button	4
16-0134	Blue Button	4
GE2030	Joystick	2
06-0066	Side Graphics	2
03-0050	Volume/Test Bracket	1
19-0017	Darkstalker Manual	1
06-0075-01	Instruction Decal, Right	1
06-0075-02	Instruction Decal, Left	1

DK1000B

Darkstalker B Kit

Part No.	Description	Qty.
DK1400B	Darkstalker "B" Board	1
06-0074	Blue Overlay	1
06-0095	Darkstalker Marquee	1
06-0075-01	Instruction Decal, Right	1
06-0075-02	Instruction Decal, Left	1
19-0017	Darkstalker Manual	1

CONTROL LOCATIONS

1. SAMPLE CONTROL PANEL LAYOUT

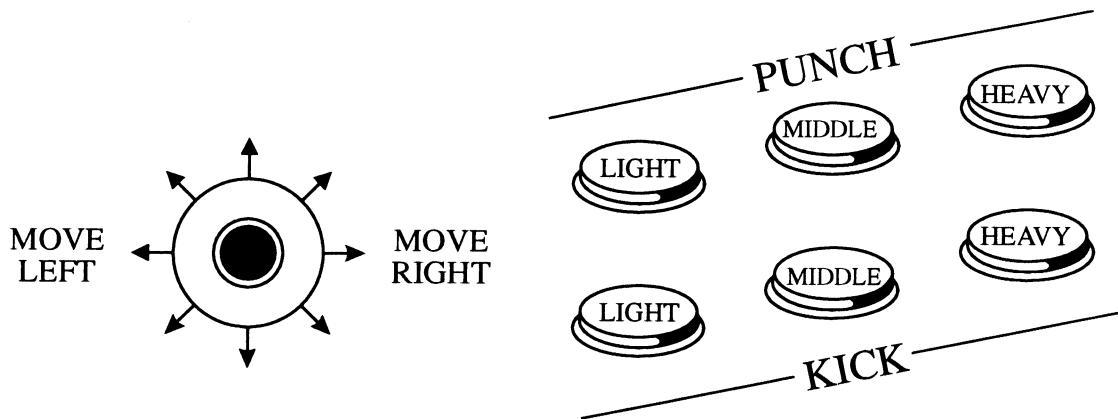

2. VOLUME AND TEST CONTROL SWITCHES ON BOARD

The volume of this unit can be adjusted by pressing the volume-up switch and the volume-down switch. **The setting you have selected will be stored even if the power is turned off.** In the event that the volume setting does not work properly, press down on either the volume-up or the volume down button **for at least five seconds, then set the volume again.**

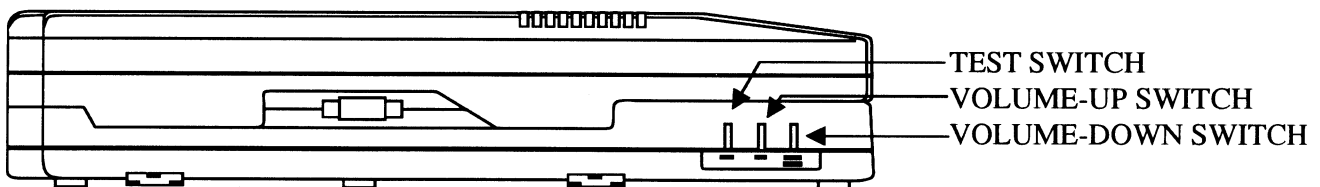

3. VOLUME AND TEST CONTROL BRACKET

To be mounted on top of the coin box. (Not included in "B" kit)

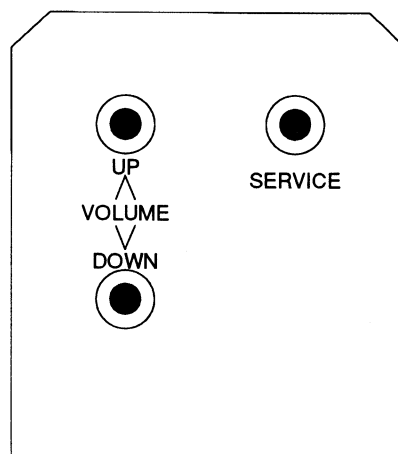

CONNECTORS

- **JAMMA:** JAMMA 56-pin connector
- **OPTION:** Player 3 and Player 4 Interface
- **AUDIO OUT:** Used only for CAPCOM QSOUND cabinet
- **REGISTER:** Optional I/O connector for register

JAMMA CONNECTOR

OPTION CONNECTOR

SOLDER SIDE			COMPONENT SIDE
GND	A	1	GND
GND	B	2	GND
+5V	C	3	+5V
+5V	D	4	+5V
N.C.	E	5	N.C.
+12V	F	6	+12V
	H	7	
N.C.	J	8	COUNTER 1
LOCK OUT 2	K	9	LOCK OUT 1
SPEAKER (-)	L	10	SPEAKER (+)
N.C.	M	11	N.C.
VIDEO GREEN	N	12	VIDEO RED
VIDEO SYNC	P	13	VIDEO BLUE
FREE CREDIT	R	14	VIDEO GND
N.C.	S	15	DIAGNOSTICS
2P COIN	T	16	1P COIN
2P START	U	17	1P START
2P UP	V	18	1P UP
2P DOWN	W	19	1P DOWN
2P LEFT	X	20	1P LEFT
2P RIGHT	Y	21	1P RIGHT
2P LIGHT PUNCH	Z	22	1P LIGHT PUNCH
2P MIDDLE PUNCH	a	23	1P MIDDLE PUNCH
2P HEAVY PUNCH	b	24	1P HEAVY PUNCH
N.C.	c	25	N.C.
N.C.	d	26	N.C.
GND	e	27	GND
GND	f	28	GND

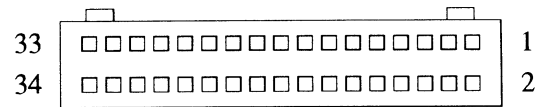
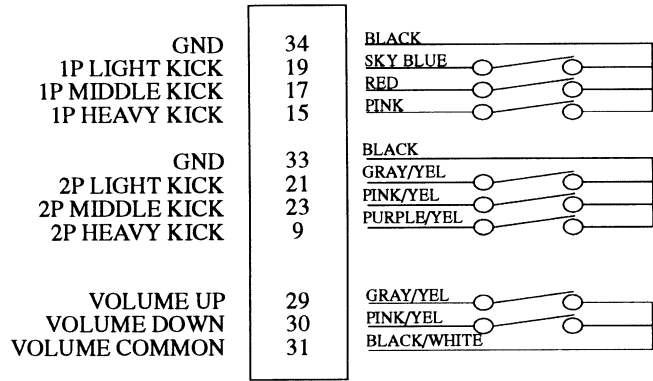

Harness Side

Note: The harness provided with this kit is fully stuffed with wires. Only the wiring above is required for use with the Darkstalker game. If you are converting from a Super Street Fighter or Super Street Fighter Turbo, you can use the existing harness in the game.

CONNECTOR LOCATIONS

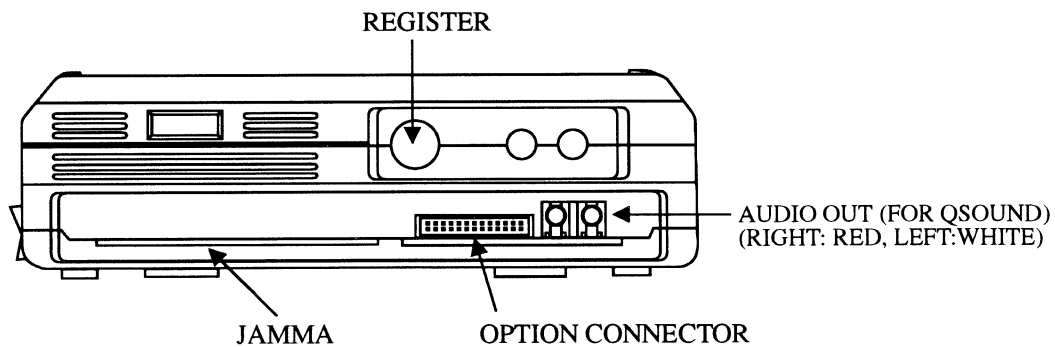

TEST MENU

The test menu allows you to test the functions and controls of the game. These items include input devices such as joysticks, buttons and coin mechs, output devices such as monitor, speakers and meters. Through the Test Menu you can also access the Configuration Menu, where you can change the settings of the game.

1. ACCESSING THE TEST MENU

- **For a CAPCOM cabinet, or a cabinet equipped with a test switch:**
Turn on the main switch, then push the test switch. The screen shown below will appear.
- **For a cabinet without a test switch:**
Push the test switch on the side of the blue plastic electronic casing. Refer to the Controls Section of the manual.

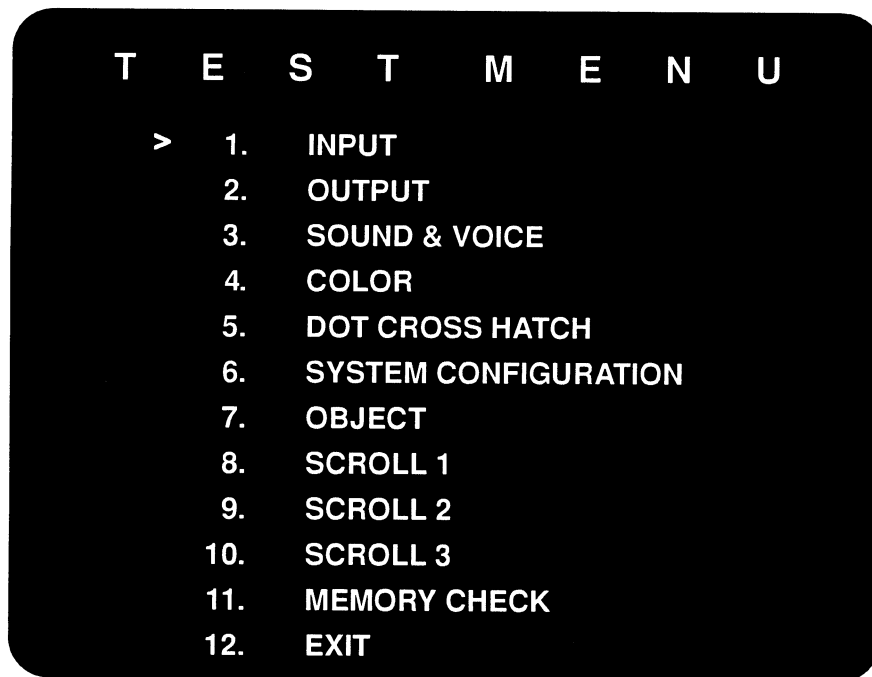

2. HOW TO SELECT AN ITEM

- Use the Player 1 Joystick to Move the arrow in front of the desired item and press the Player 1 PUNCH LIGHT button.
- To return to the test menu, push the Player 1 Start and Player 2 Start Buttons simultaneously. The test menu automatically appears:
 - After you exit the "**6. SYSTEM CONFIGURATION MENU**".
 - After the memory is tested on the menu of "**11. MEMORY CHECK**".

3. CLOSING THE TEST MENU

To close the Test Menu, highlight "**12. EXIT**" and push the Player 1 LIGHT PUNCH button.

4. TEST MENU ITEM DESCRIPTIONS

INPUT	Used to test all the input switches. "1" appears when the switches are depressed. Check connections and switches in case "0" appears when switches are depressed.
OUTPUT	Used to test the coin meter and the coin lock
SOUND & VOICE	Select a code of SOUND or VOICE with the Player 1 Joystick. Push the Player 1 A (LIGHT PUNCH) button to hear the sound of the selected code, then adjust the volume.
COLOR	Shows color bars of red, green, blue and white. Adjust RGB and brightness to obtain the optimum color balance and solid black background.
DOT CROSS HATCH	Used to test the screen size, focus and distortion.
CONFIGURATION	Used to change the game play settings. Refer to the CONFIGURATION MENU section.
OBJECT/SCROLLS	Used to check all the characters of the game.
MEMORY CHECK	Used to test memory. "OK" appears when each block of memory passes test "ERROR" appears in case of malfunction. If "ERROR" appear, repeat the memory test. Contact your distributor if "ERROR" still appears.
EXIT	Select this item and push the Player 1 (Light Punch) button to return to game play mode.

SYSTEM CONFIGURATION MENU

1. TO OPEN THE MENU

- From the Test Menu, move the A character to "**6. SYSTEM CONFIGURATION**" and push the Player 1 LIGHT PUNCH button. The screen below will be displayed.



2. CHANGING THE CONFIGURATION SETTINGS

- Move the Player 1 Joystick UP or DOWN to highlight the desired option. Once the option is highlighted, move the Joystick LEFT or RIGHT to change the setting. Refer to the menu on the next page for option settings.

3. SAVING SETTINGS AND CLOSING THE MENU

- Once the configuration settings are changed, save the new settings by selecting "**EXIT**" and pushing the Player 1 START button.
- A message "**SAVING NEW CONFIGURATION IN EEPROM**" appears while new settings are being saved. It takes one or two seconds to save the new settings. Do not turn off the power switch while saving is in process.

4. SYSTEM CONFIGURATION MENU OPTIONS

COIN	1 COIN 1 CREDIT	1 COIN 2 CREDITS	1 COIN 3 CREDITS	1 COIN 4 CREDITS	1 COIN 5 CREDITS
	1 COIN 6 CREDITS	1 COIN 7 CREDITS	1 COIN 8 CREDITS	1 COIN 2 CREDIT	2 COINS 1 CREDIT
	3 COINS 1 CREDIT	4 COINS 1 CREDIT	5 COINS 1 CREDIT	6 COINS 1 CREDIT	7 COINS 1 CREDIT
	8 COINS 1 CREDIT	9 COINS 1 CREDIT			
GAME DIFFICULTY	1 EASIEST	2 VERY EASY	3 EASY	4 MEDIUM	LEVEL 5 MEDIUM HARD
	LEVEL 6 HARD	LEVEL 7 VERY HARD	LEVEL 8 HARDEST		
DAMAGE LEVEL	1 MINIMUM	2	3	4	5 MEDIUM
	6	7	8	9 MAXIMUM	
TIME COUNT SPEED	SLOW COUNT DOWN		NORMAL COUNT DOWN	FAST COUNT DOWN	
SOUND	STEREO (Q SOUND)			MONAURAL	
DEMO SOUND	ON			OFF	
CONTINUE	ON			OFF	
START MODE	ON			OFF	
MONITOR FLIP	ON			OFF	
MAX ROUND	1 ROUND	3 ROUNDS		5 ROUNDS	
REGULATION	ON			OFF	
FREE PLAY	ON			OFF	

- Factory settings are in bold face.
- After you change the setting, make sure to select "EXIT" and push the Player 1 Start button.
- Choose **STEREO (QSOUND)** if your cabinet is equipped with the Qsound Speaker System, otherwise select **MONAURAL** for proper sound effect.

5. SYSTEM CONFIGURATION ITEM DESCRIPTIONS

COIN	Sets the charge per play
GAME DIFFICULTY	The higher the number, the more difficult the game play.
DAMAGE LEVEL	Sets the level of offensive power. The level of offensive power can be set in 9 steps. As the number increases the more powerful the level
MONITOR FLIP	Flips the screen. If the screen appears upside down, change the setting. ON: Upside down OFF: Right side up
SOUND	STEREO or MONAURAL . STEREO: with QSOUND MONAURAL: without QSOUND QSOUND is available with CAPCOM QSOUND cabinets only. For other cabinet, please set to MONAURAL
DEMO SOUND	Turns attract sound on or off.
CONTINUE	Sets continuous play. ON: Continuous play is possible OFF: Continuous play is not possible
START MODE	Sets whether or not it is possible to start a 1 player game from the 2 player side. ON: Game can be started from the 2 player side. OFF: Game cannot be started from the 2 player side.
MONITOR FLIP	Flips screen vertically. If the screen appears upside down, change the setting.
MAX ROUND	Sets the number of rounds for winning. 1 ROUND: Winner of a single round wins 3 ROUNDS: Winner of 2 out of 3 rounds wins. 5 ROUNDS: Winner of 3 out of 5 rounds wins.
REGULATION	When set to ON, body cutting scenes will not be shown and the color of blood will be changed to blue.
GAME SPEED	Sets the game speed. TURBO 1 - 3: As the number increases, so does the speed. FREE SELECT: Players can select the speed of the game.
FREE PLAY	Sets the game for free play mode.
FACTORY SETTING	To return to the factory default settings, select this item and push the PLAYER 1 START button.
EXIT	To save the setting changes and return to the TEST MENU , highlight this item and push the PLAYER 1 START button.

MOUNTING THE PC BOARD

1. INSTALLING THE MOUNTING BRACES

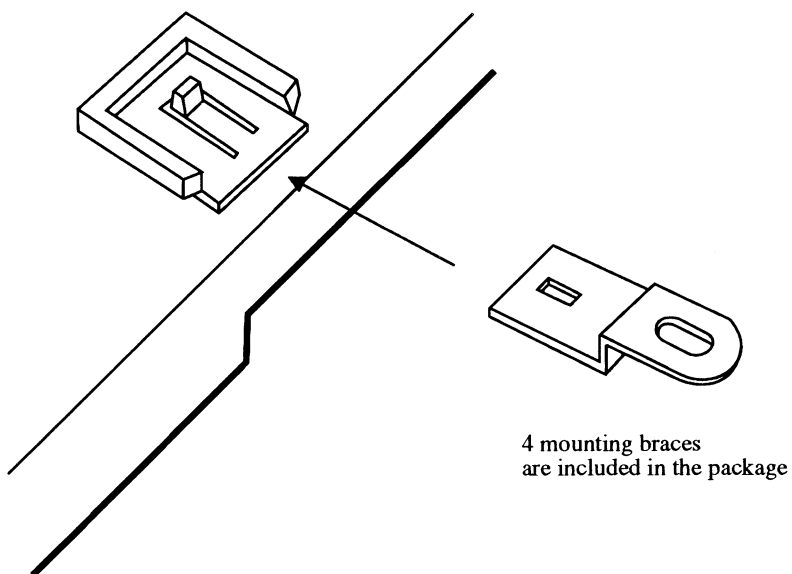

2. MOUNTING THE PCB

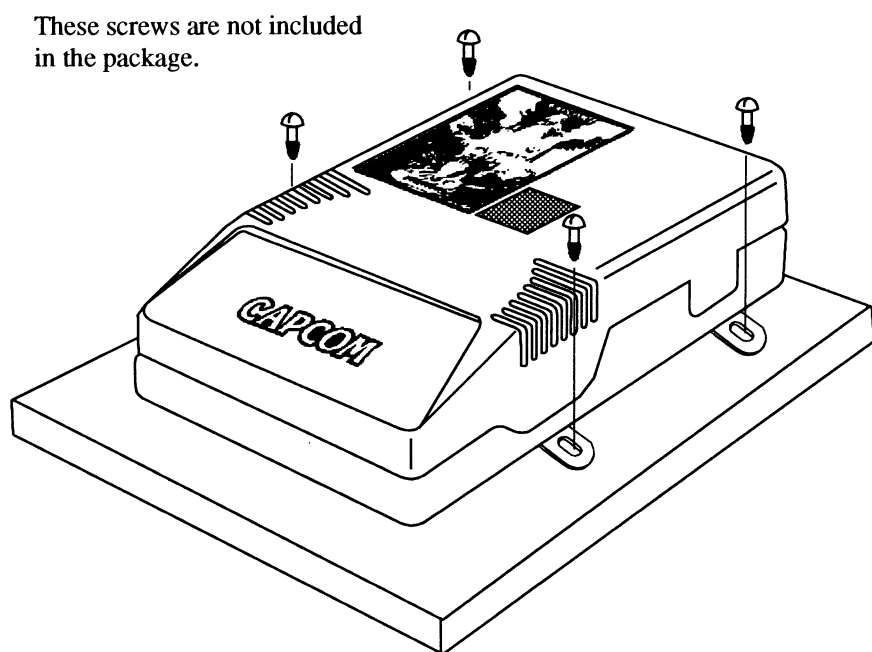

HOW TO REMOVE THE TOP "B" CARTRIDGE

In the future, there will be the capability to remove the top "B" cartridge so that a game can be converted to a new game or upgraded to a different version. It is very important only to separate the top cartridge from the main board only. **Dissassembling either case will void your warranty.** Follow the instructions below to separate the two assemblies.

- Remove the 2 case clamps.
- Carefully pull the the "B" cartridge off the bottom cartridge.

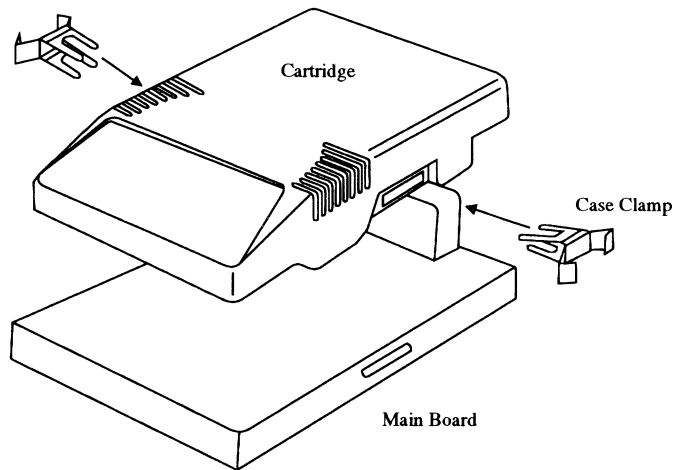

STICKER DESCRIPTIONS

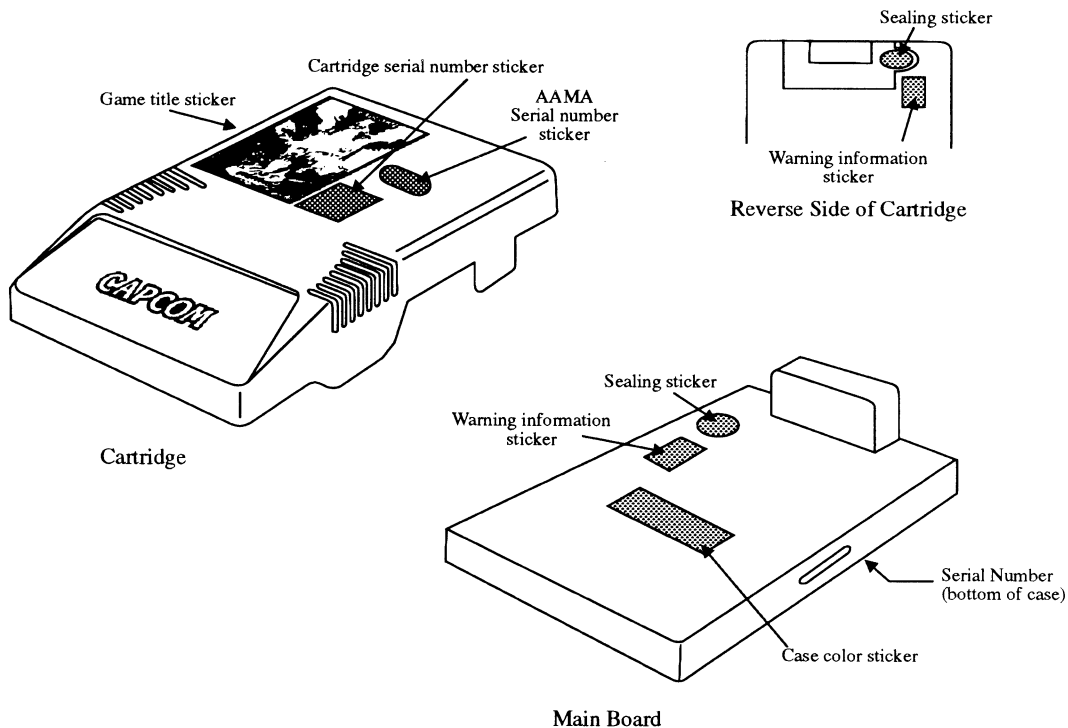

Disassembling the case or removing the sealing stickers will void your warranty!

CAPCOM®

535 Oakmead Parkway
Sunnyvale, CA 94086