

CONGORILLA

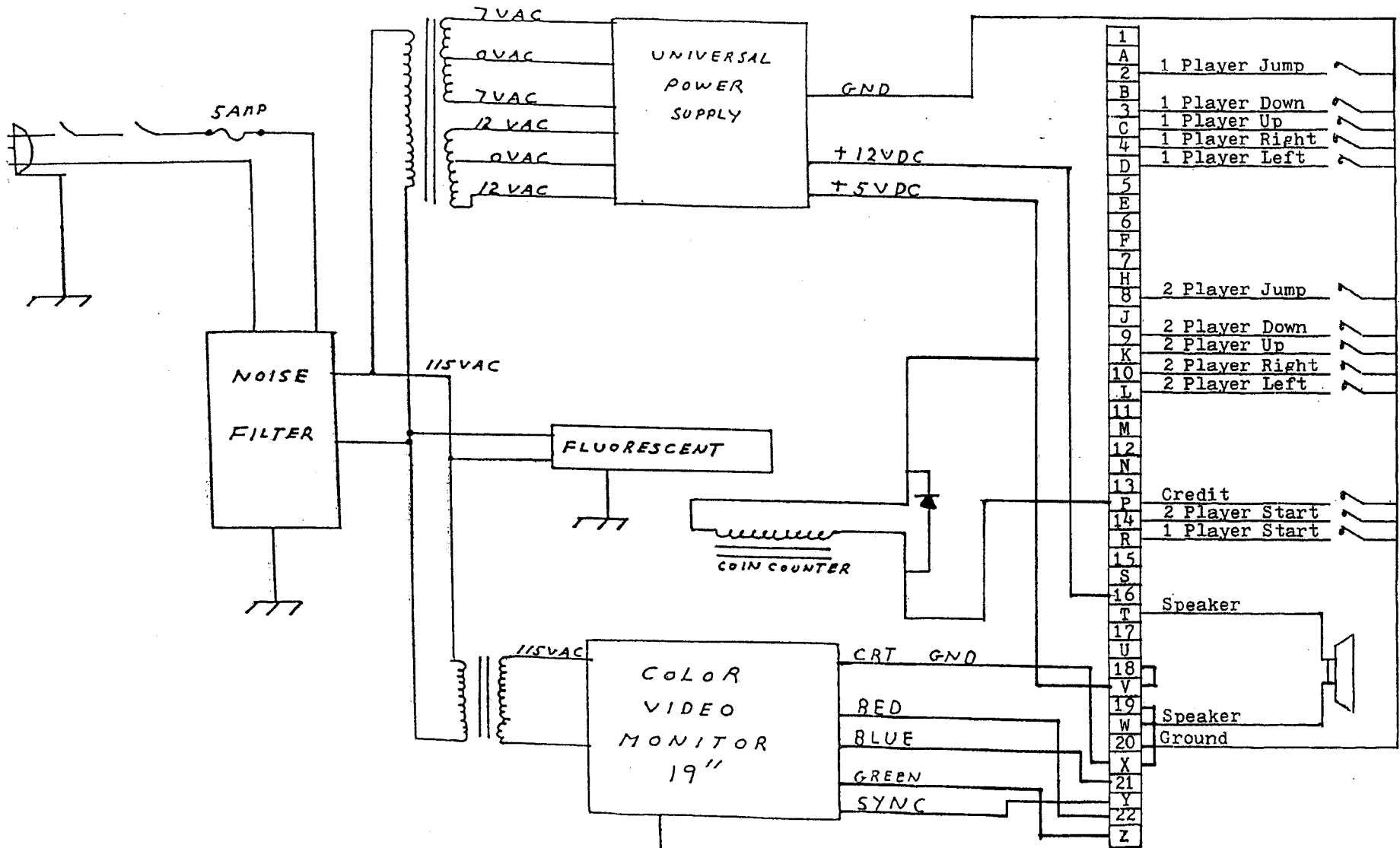

Manual



" CONGORILLA "

" C O N G O R I L L A "

Power Supply Connections

Socket P-1

1 12 VAC
 2
 3 12 VAC
 4 12 VCT
 5
 6 7 VAC
 7 7 VAC
 8
 9 7 VCT

Socket P-2

1 Gnd
 2
 3 Gnd
 4 -12 VDC
 5
 6 -20 VDC un reg
 7 -5 VDC
 8
 9 +20 VDC un reg
 10 +5 VDC
 11
 12 -10 VDC un reg
 13 +12 VDC
 14
 15 +9 VDC un reg

BIT SWITCH OPTIONS

Sw / Function	1	2	3	4	5	6	7	8
3 Gorillas	OFF	OFF						
4 Gorillas	ON	OFF						
5 Gorillas	OFF	ON						
6 Gorillas	ON	ON						
Bonus Gorilla @								
7000 Points			OFF	OFF				
10000 Points			ON	OFF				
15000 Points			OFF	ON				
20000 Points			ON	ON				
1 Coin 1 Play					OFF	OFF	OFF	
1 Coin 2 Play					OFF	ON	OFF	
1 Coin 3 Play					OFF	OFF	ON	
1 Coin 4 Play					OFF	ON	ON	
2 Coin 1 Play					ON	OFF	OFF	
3 Coin 1 Play					ON	ON	OFF	
4 Coin 1 Play					ON	OFF	ON	
5 Coin 1 Play					ON	ON	ON	
Up Right Table								ON OFF

" C O N G O R I L L A "
Edge Connector Harness

1		A	
2	1 Player Jump	B	
3	1 Player Down	C	1 Player Up
4	1 Player Right	D	1 Player Left
5		E	
6		F	
7		H	
8	* 2 Player Jump	J	
9	* 2 Player Down	K	* 2 Player Up
10	* 2 Player Right	L	* 2 Player Left
11		M	
12		N	
13		P	Credit
14	2 Player Start	R	1 Player Start
15		S	
16	+12 VDC	T	Speaker
17		U	Coin Counter
18	+5 VDC	V	+5 VDC
19	Pwr Gnd	W	Speaker
20	Gnd	X	Video Gnd
21	Video Blue	Y	Sync
22	Video Red	Z	Video Green

* For cocktail table only, make following wire modifications.

- 9 2 Player Up
- 10 2 Player Left
- K 2 Player Down
- L 2 Player Right

Number side is component side.
Letter side is solder side.

UNIVERSAL POWER SUPPLY
Outline Drawing

Page #4

+12V Adjust

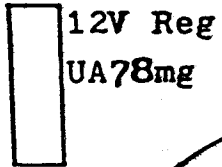
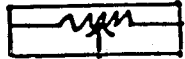

12V Reg
UA78mg

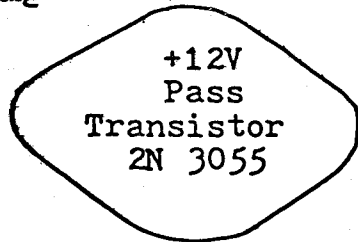

7912 -12V Reg.

7905 -5V Reg.

1/2 Amp Fuse



5 Amp Fuse



1 Amp Fuse

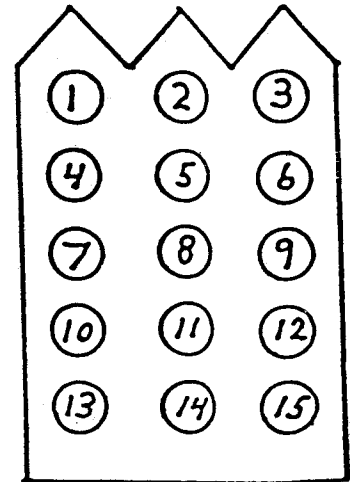

Socket P-2

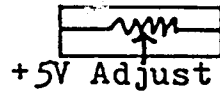

+5V Adjust



5V Reg
UA78MG

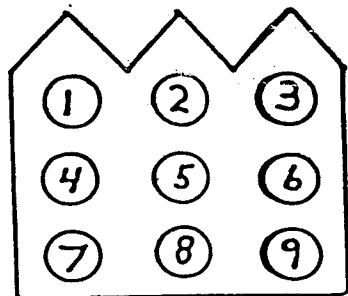
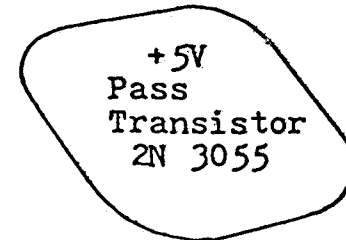

Socket P-1