

SEE CENTER PAGE FOR
CONTROL PANEL TEMPLATE

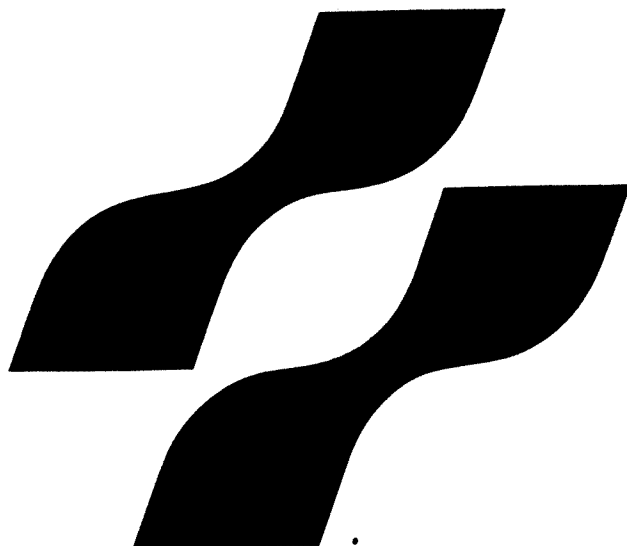

KONAMI®

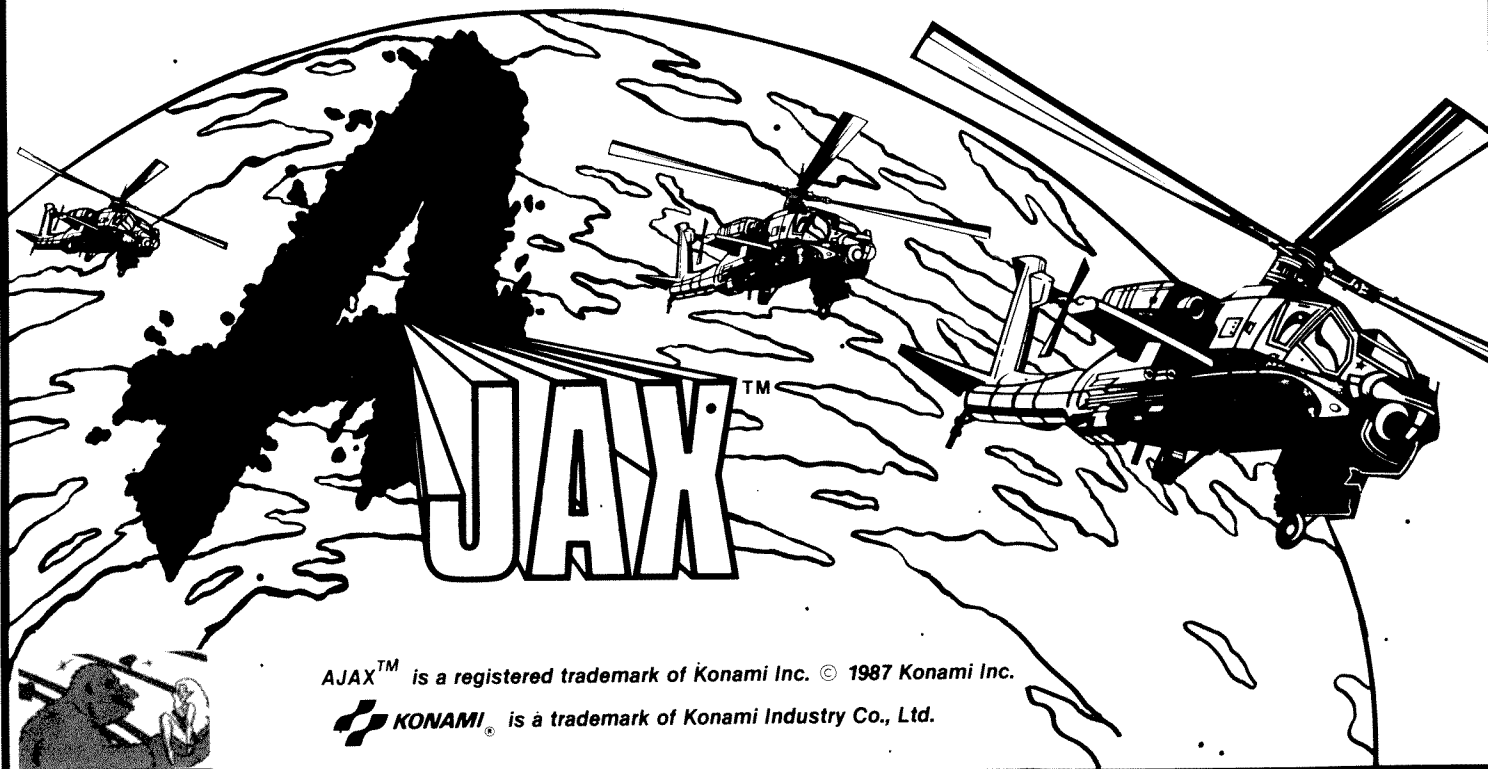

AJAX™ is a registered trademark of Konami Inc. © 1987 Konami Inc.

 KONAMI® is a trademark of Konami Industry Co., Ltd.

TABLE OF CONTENTS

	Page		Page
Conversion Kit Contents . . . Inside Front Cover		Wiring Harness Color Code	9
Introduction	1	Wiring Diagram	10
Graphics	2	Technical Information	11, 12
New Product Information	3	Troubleshooting Guide	11
Monitor Information	4	Dip Switch Settings	Inside Back Cover

CONVERSION KIT CONTENTS:

- MAIN PRINTED CIRCUIT BOARD
- P.C.B. CAGE (FCC REQUIRED)
- CONNECTING WIRING HARNESS
- 8 SETS — BUTTON ASSEMBLIES
- ONE 8-WAY JOYSTICK
- MARQUEE (HEADER)
(1/8" acrylic sheet)
- ONE SET SIDE PANEL GRAPHICS (left & right)
- CONTROL PANEL OVERLAY
- CONTROL PANEL DECALS
instruction decals/button decals (2 sets)
- MANUAL
- REGISTRATION CARD

REPLACEMENT ACCESSORIES ARE AVAILABLE THROUGH YOUR DISTRIBUTOR.

THIS KIT USABLE FOR UPRIGHT VIDEO GAMES WITH A
RASTAR SCAN MONITOR WHICH IS OR CAN BE MOUNTED VERTICALLY.

AJAX: INTRODUCTION

KONAMI CONVERSION KITS are the most complete conversion kits available today. Every detail has been carefully considered, designed and packaged to provide you the means of easily producing a professional conversion.

These kits have all the accessories to easily convert your UPRIGHT video game.

We strongly urge you to FULLY STUDY this instruction manual BEFORE you begin your conversion. It contains step-by-step instructions, schematic diagrams and suggestions on how to install your Konami Conversion Kit and maximize your profits.

AJAX can be installed in any vertically mounted raster scan monitor game.

Everything you will need to construct your new game is provided in this kit. All accessory parts—wiring harness, joystick, etc. are custom made for AJAX by top engineers experienced in the coin-op industry. One 8-way joystick (as provided) MUST be used.

The Player Instruction and Button Control decals are made of a non-destructible acrylic material specifically to keep the player from peeling them off.

★ ★ ★ IMPORTANT NOTICE ★ ★ ★

The Japanese Amusement Machine Manufacturers Association (JAMMA) has introduced a new standard in video game P.C.B.'s. It was decided that all new products from any JAMMA member will use the same pin print-out on the edge connector. The edge connector will have 56 pin outs, 28 per side.

Konami Inc. will offer a 56 to 36 pin adaptor P.C.B. available through your distributor. This new adaptor P.C.B. will enable the new 56 pin out to adapt to Konami's old standard 36 pin out.

★ ★ ★ STEREO SOUND ★ ★ ★

AJAX offers stereo sound in this kit.
Please see page 12 for proper installation.

PUTTING YOUR BEST GAME FORWARD

PREPARATION:

For best results, all old graphics should be removed completely from the cabinet. "Stick-on" graphics can be removed by using a hairdryer or hot air device. The heat from the dryer will loosen the adhesive, allowing you to easily peel them off — any adhesive residue can be cleaned off with acetone and a soft dry cloth. (DO NOT USE ACETONE ON SURFACES PAINTED WITH FLAT PAINT.)

TOOLS YOU NEED:

1. Foaming Aerosol (such as "Windex").
2. Soft Squeegee.
3. X-Acto Knife.

SIDE PANEL DECALS

1. Spray area of cabinet where Side Panel decals are to be applied with foaming aerosol or a mild soap solution.
2. Remove protective backing from decals.
3. Position decals into place.
4. With a soft squeegee, beginning from the center of the decal, slowly and evenly press out excess foam until you achieve a smooth finish.
5. Allow to set approximately 2 to 3 hours before handling. Maximum adherence is achieved in 48 to 72 hours.

6. Trim side decal to fit your cabinet.

CONTROL PANEL OVERLAY:

1. Refer to Recommended Control Panel Layout on page 1.
2. Drill any new holes needed.
3. Plug any holes that will not be used. (A permanent epoxy-filler works well for this step.)
4. Pre-position the overlay prior to removing the backing.
5. Slowly apply the overlay — inch by inch on the control panel, removing the backing as you apply it.
6. Once it's in place, by using an X-Acto knife, cut around the button and joystick placements.

INSTRUCTION/BUTTON DECALS:

Apply the Player Instruction, Button and 1 Player/2 Player decals in their respective positions. Apply pressure liberally. Allow to set as long as possible before putting game on location.

NOTE: Maximum adherence is achieved in 48 to 72 hours.

FCC WARNING LABEL:

FCC Warning Label must be applied to the outside of the cabinet near the line cord entry.

MARQUEE

(WEAR PROTECTIVE GLASSES WHILE TRIMMING MARQUEE)

1/8" Acrylic Marquee should be cut to fit your game. DO NOT remove protective mask until this is done.

One way of cutting your Marquee is as follows: (Be sure to protect painted side of Marquee from any surface which may scratch or mar finish).

CUTTING WITH A KNIFE OR SCRIBER

Acrylic sheet up to 3/16" thick may be cut by a method similar to that used for cutting window glass. Use a scribe of some kind — a scribing knife such as the one pictured, a metal scribe, an awl, or even a sturdy craft knife — to score the sheet. Draw the scribe several times (7 or 8 times for a 3/16" thick piece) along a straight edge held firmly in place. It is best not to remove the protective masking. Make the cuts carefully using firm, even pressure. For best results make each stroke cleanly off the edge of the sheet.

Then clamp the acrylic sheet or hold it rigidly under a straight edge with the scribe mark hanging just over the edge of a table. Protect your hands with a cloth, and apply a sharp downward pressure to the other side of the sheet. It will break along the scratch. Scrape the edges to smooth any sharp corners. This method is not recommended for long breaks or thick material.

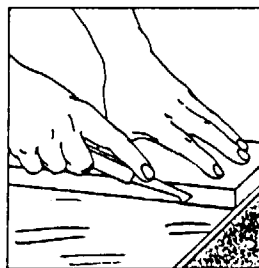

Always draw the scribing knife along a straight edge.

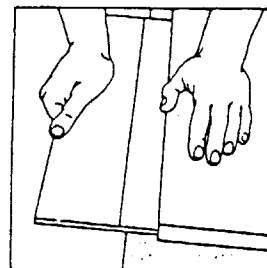

Break sheet over edge of table after scribing.

P.C.B. CAGE INSTALLATION

Konami, Inc. now supplies a new style P.C.B. cage which is superior to old style cages because of ease of installation. The cage is made of a 32 point stem-stock which is fire retardant.

TO INSTALL THE CAGE:

1. Open cage bottom and secure to desired P.C.B. position.
2. Install printed circuit board inside cage using wood screws, screwed through the cage bottom into cabinet side.
3. Close the cage over printed circuit board and secure with latch on cage.

NEW PRODUCT FROM



All new Konami P.C.B.'s utilize a 56 pin edge connector. This connector complies with the standard set by JAMMA (Japanese Amusement Machine Manufacturers Association). However, all Konami P.C.B.'s manufactured prior to Top Gunner utilize a 36 pin edge connector. These games include Super Cobra, Scramble, Pooyan, Locomotion, Circus Charlie, L'il Hustler, Juno First, Time Pilot, Gyryuss, Tutankham, Turtles, Super Basketball, Mega Zone, Pandora's Palace, Time Pilot '84, Track 'N' Field, Hypersports, Road Fighter, Yie-Ar Kung Fu, Kicker, Rush 'N' Attack, Mikie, Frogger, Amidar, Roc 'N' Rope, The End, Jail Break, and Nemesis.

Because of the large amount of video game cabinets that are wired for Konami's old standard edge connector, Konami now offers 36 to 56 pin adaptor P.C.B.'s. This adaptor P.C.B. enables you to simply plug in a new 56 pin JAMMA P.C.B. (not only Konami's) **rather than rewiring.**

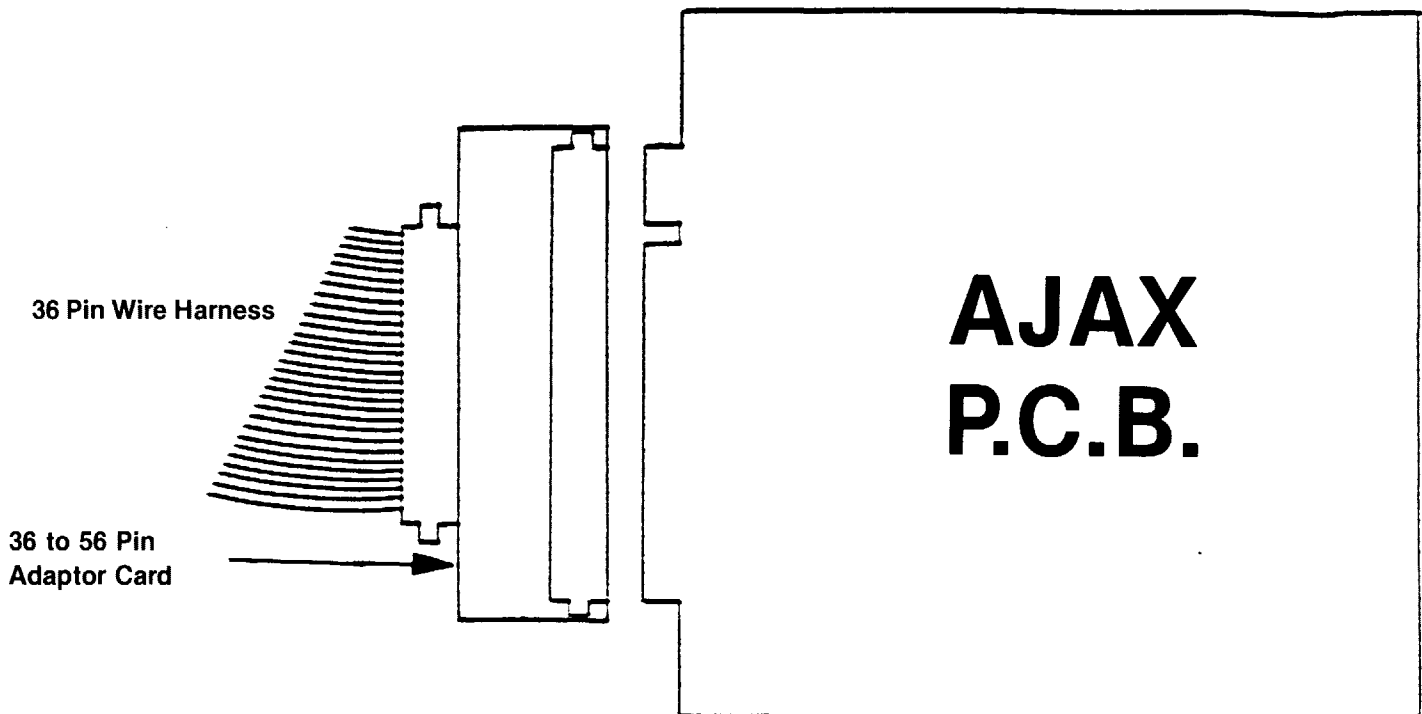

Please contact your distributor for price and delivery!

AJAX: MONITOR INFORMATION

SERVICE INSTRUCTIONS

NOTE: All monitors are equipped with automatic degaussing coils (L701) which demagnetize the picture tube every time the monitor is turned on after being off for a minimum of 5 minutes. Should any part of the chassis become magnetized it will be necessary to degauss the affected area with a manual degaussing coil. Move the coil slowly around the CRT face and all surrounding metal parts. Then slowly withdraw for a distance of 6 feet before turning off.

1.0 BLACK LEVEL CONTROL ADJUSTMENT

This control has been set at the factory and should not need further attention, however, when the game is connected a slight adjustment of VR201 may be necessary to obtain the proper black level (the black portion of the picture just extinguished).

2.0 VERTICAL SIZE (HEIGHT)

Location of this control is shown in Fig. 1. This control must be adjusted slowly, if necessary, until the picture or test pattern attains the correct vertical proportions.

3.0 CIRCUIT PROTECTION

A 4.0A pigtail fuse, mounted on the Main Board has been provided to protect the Power Output Circuit.

4.0 FOCUS

Adjust the focus control, located on the HV unit (T352), for maximum over-all definition and fine picture detail.

5.0 HORIZONTAL HOLD CONTROL ADJUSTMENT, VR351 (See Fig. 1)

A warm-up period of at least five minutes should be allowed before alignment is carried out. With the monitor being driven from the game signal, short TP601 to TP31. Adjust VR351 until the picture stops sliding horizontally. Remove the short.

6.0 HORIZONTAL VIDEO POSITION

If the video is off center on the raster some compensation can be made by adjusting this control.

7.0 VERTICAL RASTER POSITION ADJUSTMENT

If the video is off center vertically, (short dimension of picture tube) some compensation can be made by moving the vertical raster position adjustment jumper to either positions "U" or "D".

8.0 HORIZONTAL RASTER POSITION ADJUSTMENT

If the video is off center horizontally (long dimension of the picture tube) some compensation can be made by moving the horizontal raster position adjustment jumper to either positions "R" or "L".

9.0 HORIZONTAL WIDTH ADJUSTMENT

The horizontal width coil is a hexagonal tuning tool adjustment. This control must be adjusted slowly, if necessary, until the picture or test pattern attains the correct horizontal proportions.

* KONAMI GAMES ARE ALL NEGATIVE COMPOSITE SYNC. USE THE THREE PIN CONNECTOR ON THE MONITOR.

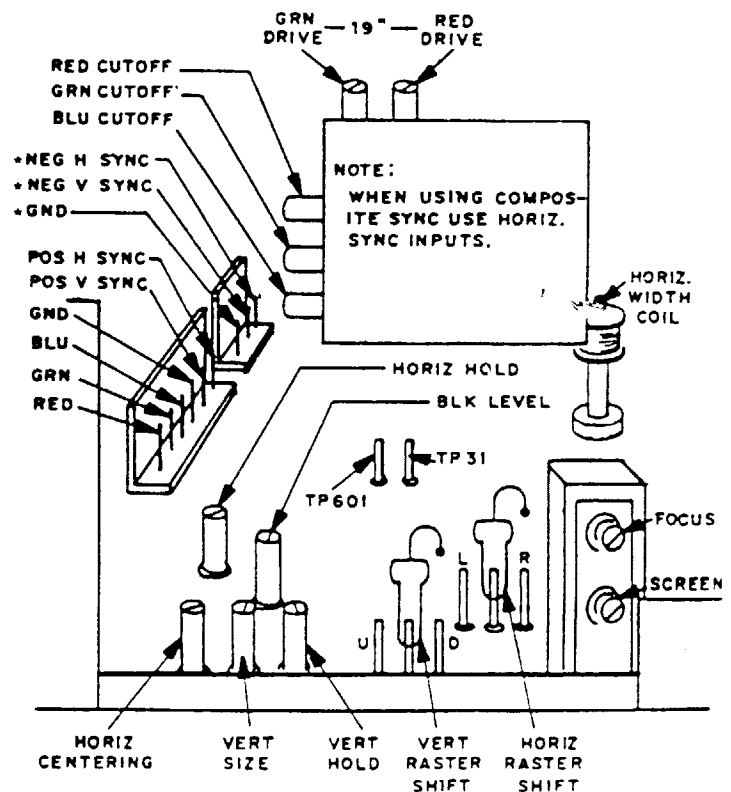

AJAX: WIRING HARNESS

WIRE COLOR KEY:		← Solder Side		Parts Side →	
BLACK	GND	A	1	GND	BLACK
BLACK	GND	B	2	GND	BLACK
RED	+ 5V DC	C	3	+ 5V DC	RED
RED	+ 5V DC	D	4	+ 5V DC	RED
GREEN	NOT USED	E	5	NOT USED	GREEN
ORANGE	+ 12V DC	F	6	+ 12V DC	ORANGE
	*KEY	H	7	*KEY	
BROWN/YELLOW	COIN COUNTER 2	J	8	COIN COUNTER 1	GREEN/GRAY
	(EMPTY)	K	9	(EMPTY)	
WHITE/BROWN	SPEAKER	L	10	SPEAKER	YELLOW/GRAY
	(EMPTY)	M	11	(EMPTY)	
WHITE/GREEN	VIDEO GREEN	N	12	VIDEO RED	RED/WHITE
WHITE	VIDEO SYNC	P	13	VIDEO BLUE	BLUE/WHITE
RED/YELLOW	SERVICE SW	R	14	VIDEO GROUND	BLACK
	(EMPTY)	S	15	(EMPTY)	
VIOLET/WHITE	COIN 2	T	16	COIN 1	BLUE/BROWN
RED/GREEN	2P START	U	17	1P START	PINK/YELLOW
BLUE/YELLOW	NOT USED	V	18	1P UP	ORANGE/WHITE
VIOLET/YELLOW	NOT USED	W	19	1P DOWN	BLACK/WHITE
ORANGE/GREEN	NOT USED	X	20	1P LEFT	RED/GRAY
ORANGE/YELLOW	NOT USED	Y	21	1P RIGHT	GRAY/WHITE
BLACK/YELLOW	NOT USED	Z	22	1P MACHINE GUN	PINK/WHITE
ORANGE/GRAY	NOT USED	a	23	1P MISSILE	GREEN/BROWN
BROWN/WHITE	NOT USED	b	24	1P SUPER WEAPON	RED/BROWN
GRAY/YELLOW	NOT USED	c	25	NOT USED	WHITE/BLACK
BLUE/GRAY	NOT USED	d	26	NOT USED	WHITE/VIOLET
BLACK	GND	e	27	GND	BLACK
BLACK	GND	f	28	GND	BLACK

(BASE COLOR/LINE COLOR)

AJAX: WIRING DIAGRAM

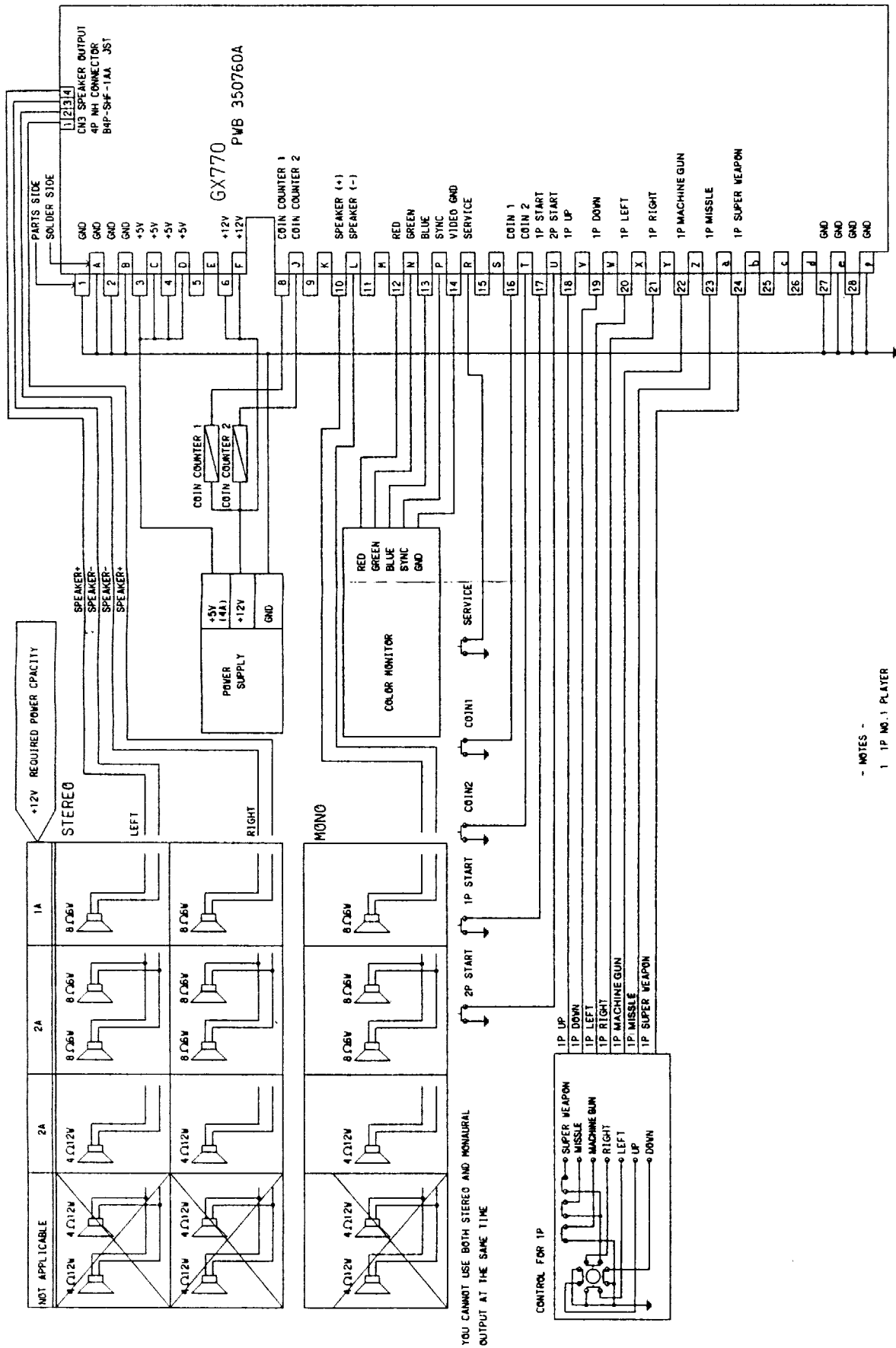

YOU CANNOT USE BOTH STEREO AND MONOURAL OUTPUT AT THE SAME TIME

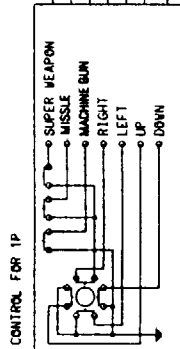

- NOTES -

- 1P NO.1 PLAYER
- 2P NO.2 PLAYER
- SURGE KILLER DIODES FOR COIN COUNTER INSTALLED ON THE P.C.B.

JAMMA 56PIN EDGE CONNECTOR
5/32 INCH PITCH

AJAX: TECHNICAL INFORMATION

AJAX requires vertically mounted monitor. It also generates composite negative sync. If your monitor is composite positive sync, you will have to change to composite negative sync.

To alternate composite positive sync to composite negative sync, use 7404 IC or 74LS04 IC. The signal on the output pin from the P.C.B. is a combination of H-sync and V-sync.

NOTE: Please refer to Figure 2.

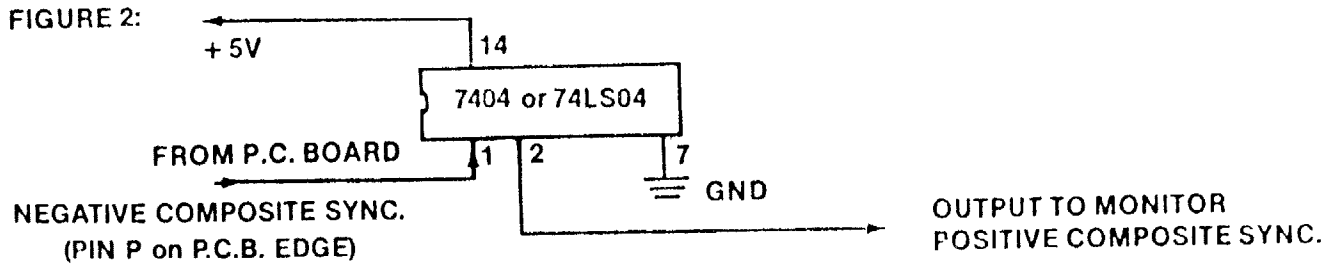

(+ 5V NS GND should be taken out of the P.C. Board.)

TROUBLE SHOOTING GUIDE

PROBLEM:	POSSIBLE SOLUTION
No Screen or Constant Reset	<ol style="list-style-type: none"> 1). Check + 5 V line at the P.C.B. 2). Make sure all socketed eproms and custom IC's are seated securely. Apply light pressure to secure. 3). Check harness to be sure it is not on backwards.
No Sound	<ol style="list-style-type: none"> 1). Check + 12V line at the P.C.B. 2). Make sure both speaker out wires are connected to the speakers. (DO NOT CONNECT A GROUND.)
Distorted Sound	<ol style="list-style-type: none"> 1). Replace cabinet speaker.
I/O Problem (coin 1 doesn't work or Joystick Up doesn't work, etc.)	<ol style="list-style-type: none"> 1). Do not hook a coin counter to the coin 1 or coin 2 outputs. This will cause damage. 2). Check your schematic for the 74LS253 IC that corresponds to your I/O problem. Check the appropriate pin with a scope or multimeter for a high output (5V), if output is low replace the 74LS253.

CAUTION

DO NOT WIRE COIN COUNTERS TO THE COIN 1 OR COIN 2 OUTPUTS. THIS WILL CAUSE DAMAGE TO THE I/O MICROCHIP 74LS253. COIN COUNTERS CAN ONLY BE WIRED TO COIN COUNTER OUTPUTS.

AJAX: TECHNICAL INFORMATION

HOW TO CHANGE MONAURAL/STEREO

Note: Mono and stereo sound cannot operate simultaneously.

FOR MONO OUTPUT: Connect the stereo-mono switching 4P connector to the mono side (CN6). Connect pin 10 and pin L at the 56 pin edge connector to the loud speaker. Use the R-volume control to adjust the sound level.

FOR STEREO OUTPUT: Connect the stereo-mono switching 4P connector to the stereo side (CN5). Connect the 4 pin socket (CN3) enclosed to CN3. Use pins 1 and 2 of the 4 pin socket (CN3) for the right hand channel. Use pins 3 and 4 of the same socket for left hand channel. Turn R-volume control clockwise and the right hand channel becomes louder. Turn L-volume control clockwise and the left hand channel becomes louder.

Note: See diagram below.

Do not use pins 10 and L on the 56 pin edge connector.

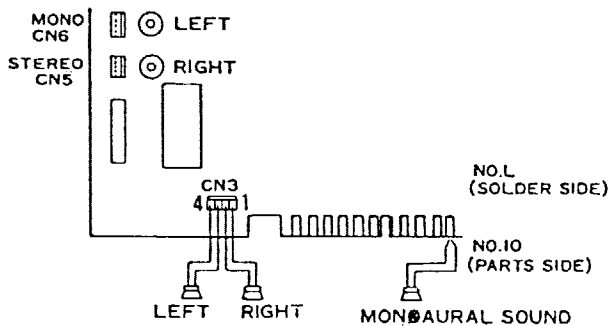

TECHNICAL INFORMATION

- (1) Required Power Capacity
GND—Vcc 5V 4A or more
GND—(+ 12V) See the WIRING DIAGRAM
- (2) Output
R(red) analog, positive
G(green) analog, positive
B(blue) analog, positive
Sync. H-V complexed, negative
- (3) Handle with care.

SELF TEST

Normal: "OK" will be displayed. Then game program will be started.

Abnormal: "BAD" will be displayed and self test will repeat itself.

MANUAL TEST

- a. How to start
Turn on the power while the SW3 of the Dip Switch No. 3 is on.
- b. Test items
 1. I/O check
 2. Coin counter check
 3. Dip switch set
 4. Distortion check
 5. Color conditioning
 6. Sound check

* Push 1P start button to change test items.

PLAY INSTRUCTION

Control your helicopter/jet fighter by using the 8-way joystick.

Destroy the enemies in the air and on the ground with two fire buttons.

Use SUPER WEAPON button to destroy all the enemies in one go. Do not waste the shells, however, as the number of shells available is limited.

Capture the symbol for an extra shell.

• POWER UP

Destroy the red enemy and capture power up capsule indicating a letter, which changes each turn. Power up feature will be decided according to the letter indicated when captured;

V VULCAN: Rapid bullets can be fired in the directions controlled.

B BOMB: Air-to-ground missiles will have extra power.

3 3-WAY: Fire bullets straight forward, straight right and left.

T TRIPLE: Bullets spread three ways in front.

L LASER: Radiate double laser.

Destroy the enemy formation in red and a capsule indicating a letter "O" appears, which does not change into other letters. Capture it to have extra firing power. Extra firing power can be obtained up to double normal power.

DIP SWITCH SETTINGS

DIP SWITCH NO. 1 SETTINGS

1. COIN 1

SW	1	2	3	4	COIN	PLAY
•	OFF	OFF	OFF	OFF	1	1
	ON				1	2
	OFF	ON			1	3
	ON				1	4
	OFF	OFF	ON	OFF	1	5
	ON				1	6
	OFF	ON			1	7
	ON				2	1
	OFF	OFF	OFF	ON	2	3
	ON				2	5
	OFF	ON			3	1
	ON				3	2
	OFF	OFF	ON	ON	3	4
	ON				4	1
	OFF	ON			4	3
	ON				FREEPLAY	

FREEPLAY: You can play game without coins.

2. COIN 2

SW	5	6	7	8	COIN	PLAY
•	OFF	OFF	OFF	OFF	1	1
	ON				1	2
	OFF	ON			1	3
	ON				1	4
	OFF	OFF	ON	OFF	1	5
	ON				1	6
	OFF	ON			1	7
	ON				2	1
	OFF	OFF	OFF	ON	2	3
	ON				2	5
	OFF	ON			3	1
	ON				3	2
	OFF	OFF	ON	ON	3	4
	ON				4	1
	OFF	ON			4	3
	ON				VOID	

5. SOUND IN ATTRACTIVE MODE

SW	8	SOUND
•	OFF	OFF
	ON	ON

SW3 should be set at ON.

DIP SWITCH NO.3 SETTINGS

1. VIDEO SCREEN FLIP

SW	1	
•	OFF	NORMAL
	ON	UPSIDE DOWN

2.

SW	2	
•	OFF	
	ON	

3. CHANGE OF MODE

SW	3	MODE
•	OFF	GAME MODE
	ON	TEST MODE

4. PLAYER'S MOVEMENT CONTROLLED BY JOYSTICK

SW	4	
•	OFF	Player goes upward by pushing joystick
	ON	Player goes downward by pushing joystick

• Shows recommended settings
SW2 is not used and should be set at OFF.

DIP SWITCH NO. 2 SETTINGS

1. THE NUMBER OF PLAYER'S LIFE

SW	1	2	NUMBER
•	OFF	OFF	2
	ON		3
	OFF	ON	5
	ON		7

2. CHANGE OF TABLE/UPRIGHT

SW	3	TYPE
•	OFF	TABLE
	ON	UPRIGHT

3. BONUS LIFE

SW	4	5	1ST	2ND
•	OFF	OFF	At 30,000 pts.	At 150,000 pts.
	ON		At 50,000 pts.	At 200,000 pts.
	OFF	ON	At 30,000 pts.	
	ON		At 50,000 pts.	

4. DIFFICULTY OF THE GAME

SW	6	7	DIFFICULTY
•	OFF	OFF	EASY
	ON		NORMAL
	OFF	ON	DIFFICULT
	ON		VERY DIFFICULT

USER INFORMATION
WARNING
F. C. C. REGULATION COMPLIANCE

THIS KIT IS INTENDED FOR USE ONLY ON COIN-OPERATED VIDEO GAMES MANUFACTURED AFTER OCTOBER 1, 1983 WHICH HAVE BEEN VERIFIED FOR COMPLIANCE WITH REQUIREMENTS IN PART 15 OF F.C.C. RULES FOR A CLASS A COMPUTING DEVICE.

IMPROPER CONNECTION OF THIS KIT OR CONNECTION TO ANY OTHER GAME NOT SO MANUFACTURED OR VERIFIED FOR COMPLIANCE MAY CAUSE UNACCEPTABLE INTERFERENCE TO RADIO AND T.V. RECEPTION, REQUIRING THE OPERATOR TO TAKE WHATEVER STEPS ARE NECESSARY TO CORRECT THE INTERFERENCE.

THE P.C. BOARD CAGE SUPPLIED WITH THIS CONVERSION KIT MUST BE UTILIZED AND TERMINATED TO GROUND AT THE TIME OF INSTALLATION.



815 Mittel Drive, Wood Dale, Illinois 60191
Telephone: (312) 595-1443, Telex: 6871385 KONAM UW, Fax: (312) 595-2973

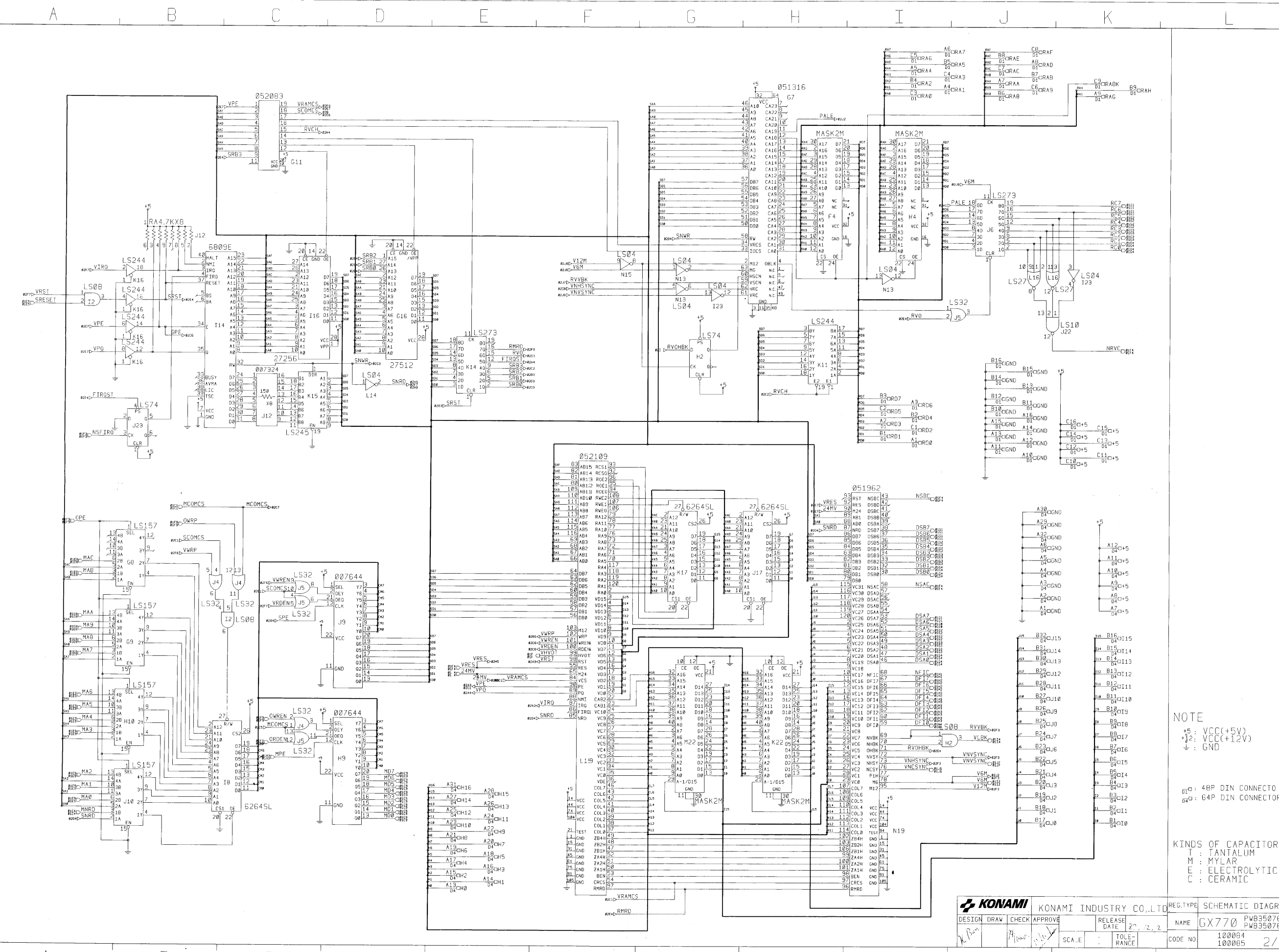

NOTE
 +5: VCC(+5V)
 +12: VCC(+12V)
 ↓: GND

05: 48P DIN CONNECTOR
 06: 64P DIN CONNECTOR

KINDS OF CAPACITOR
 T: TANTALUM
 M: MYLAR
 E: ELECTROLYTIC
 C: CERAMIC

KONAMI				KONAMI INDUSTRY CO., LTD.		REG. TYPE	SCHEMATIC DIAGRAM	
DESIGN	DRAW	CHECK	APPROVE	RELEASE DATE	27.12.2	NAME	GX770 PWB350760/PWB350760E	
SCALE	TOLERANCE		CODE NO.	100094 100065		2/3		

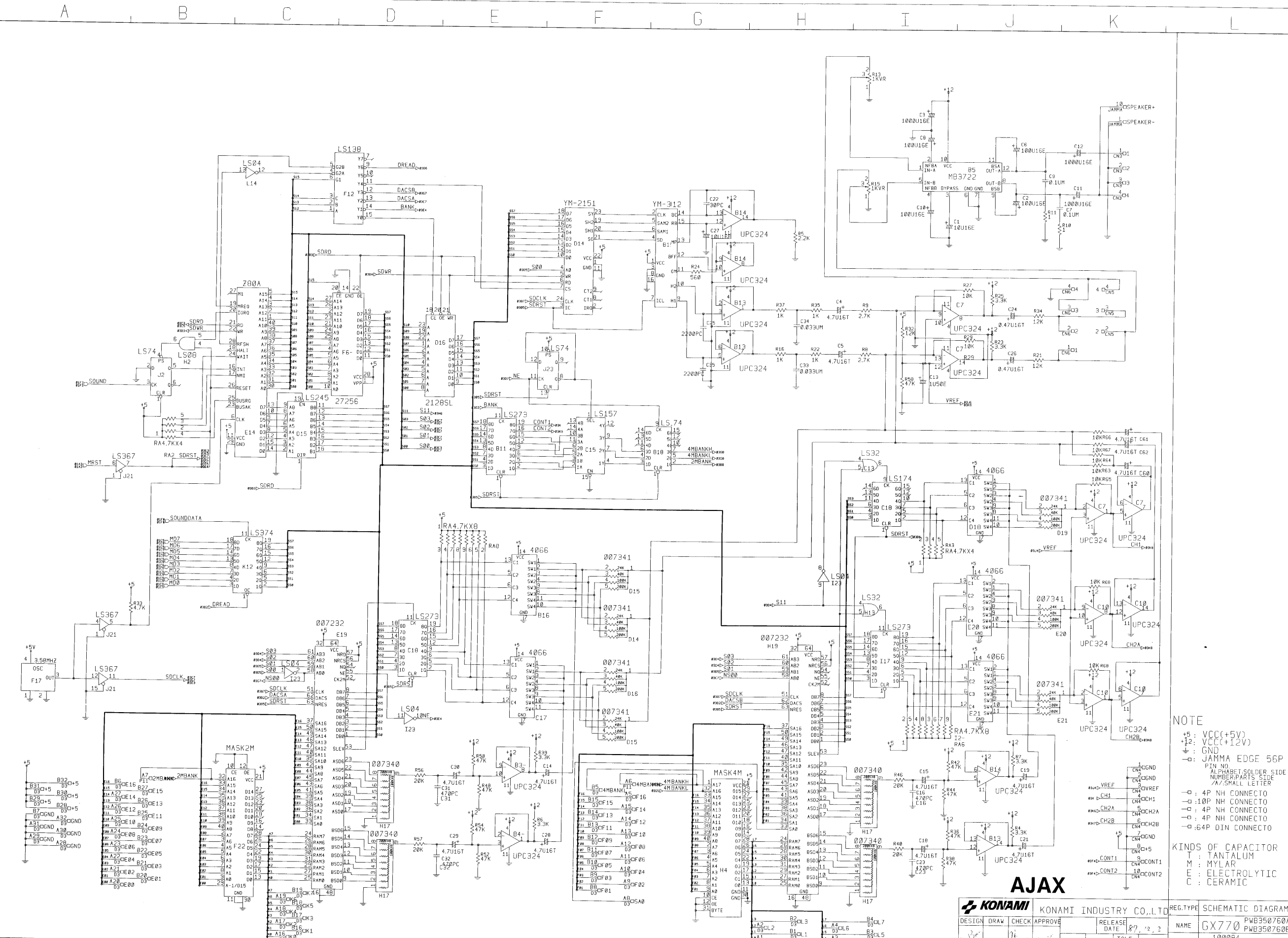

AJAX

KONAMI KONAMI INDUSTRY CO., LTD.

DESIGN	DRAW	CHECK	APPROVE	RELEASE DATE	87.12.2	REG. TYPE	SCHEMATIC DIAGRAM
				SCALE	TOLE-RANCE	NAME	GX770 PWB350760A PWB350760B
						CODE NO.	100054 100055

3/3